

High Feed and Large Depth of Cut Milling

# MFH Boost

**NEW**

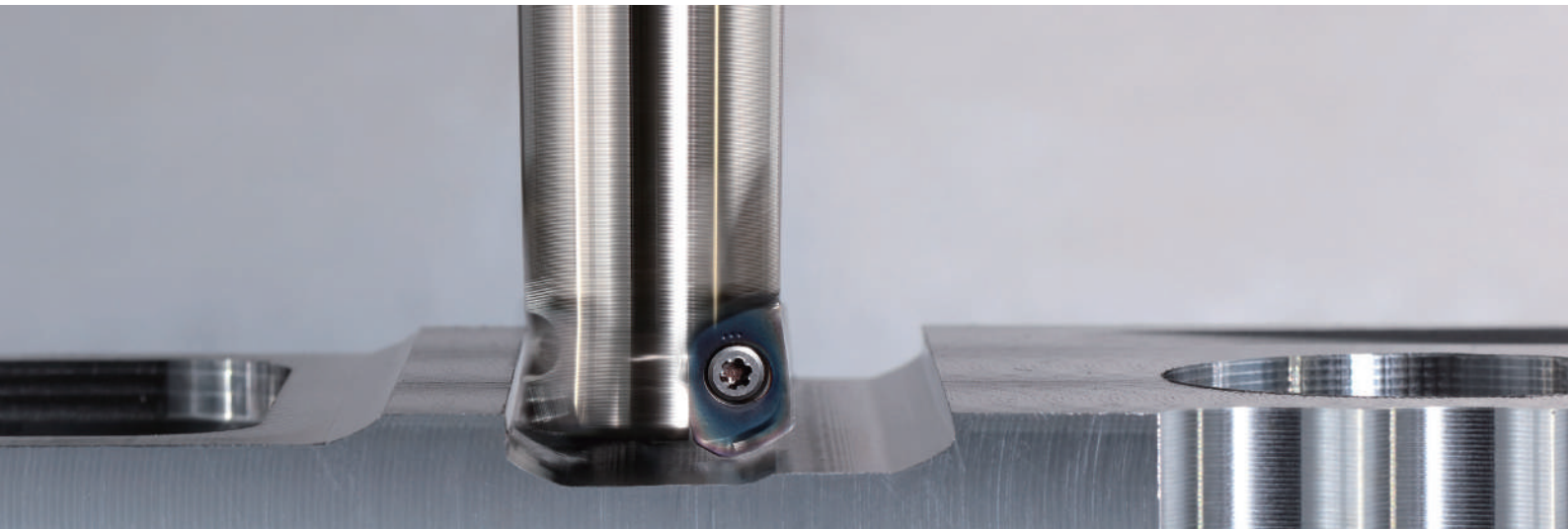

## High Feed Milling with Larger Depths of Cut

High Feed End Mills with Cutting Dia. Available from  $\varnothing 22$  and up to 2.5mm  
Depth of Cut

Excellent Performance in a Wide Range of Applications,  
including Automotive Parts, Difficult-to-cut Materials, and Molds  
Provides Multiple Solutions for Various Machining Environments

Large Lineup of End Mills, Face Mills, and Modular Types Available



High Feed and Large Depth of Cut Milling

# MFH Boost

The Newest Addition to the MFH Series - High Feed plus Large D.O.C. for Greater Milling Capabilities  
Excellent Performance in a Wide Range of Applications, including Automotive Parts, Difficult-to-cut Materials, and Molds

Video



1

## High Feed Milling with Large Depth of Cut Capabilities

A small 04 size insert (4-edge, Double-sided insert) supports depths of cut up to 2.5mm with cutting dia. available from  $\varnothing 22\text{mm}$ .

Achieves high efficiency machining in various shouldering, slotting, helical milling, and ramping applications.

4-edge, Double-sided insert

Max. Depth of Cut  
**2.5mm**

## MFH Boost Advantage

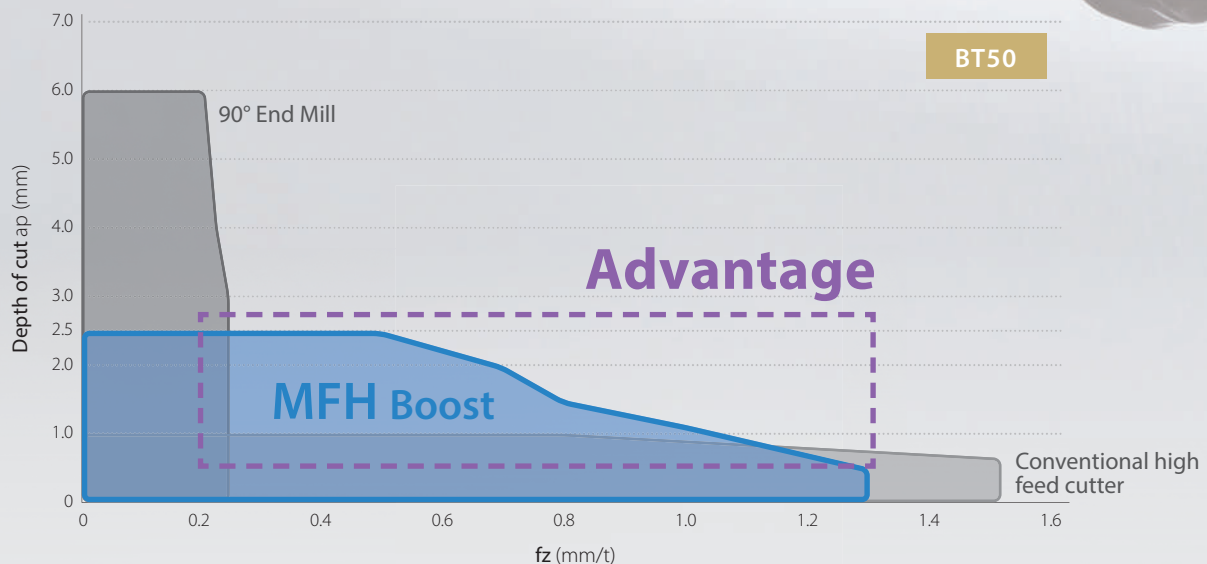

$V_c = 150 \text{ m/min}$ ,  $a_e = 12.5 \text{ mm}$  ( $a_e/DCX = 50\%$ ), S50C Dry  $\varnothing 25$  Overhang length 60 mm BT50

## New Value with 2.5mm Max. Depth of Cut

- 1 Provides a Better Alternative to Conventional **90°End Mills** (Roughing to Medium-Finishing)



Automotive Suspension Parts

### Automotive Parts

General Steel Machining

- **Increased productivity with large D.O.C. machining**
- **High reliability in unstable machining environments**  
Long overhang length and better clamping rigidity  
Stable machining with low rigidity machines
- **High-efficiency ramping**  
Large ramping angle (Small dia.  $\phi 25\text{mm}$ :  $3^\circ$ )  
Dramatic efficiency improvement when ramping in pockets
- **Longer tool life with high-efficiency machining**

- 2 Provides a Greater Solution to **Conventional High Feed Cutters**

### General Parts/Mold (High Roughing/Facing)

General Parts, Pressing and Die Casting

- **Higher productivity with large D.O.C.**
- **Long tool life and improved efficiency through the reduction of tool paths**  
Reduced machining time when machining workpieces with large variations in machining margins
- **Longer tool life with high-efficiency machining**

\*MFH Mini/Harrier recommended for contouring with small depth of cut and high feed

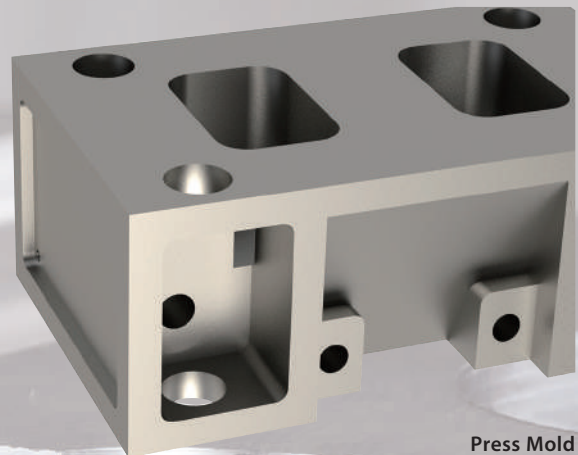

Press Mold

- 3 Solutions for Machining **Difficult-to-cut Materials**



Aircraft Landing Gear Parts

### Aircraft/Energy Industry Parts

Difficult-to-cut materials such as titanium alloy and stainless steel machining

- **High feed rates increase productivity**
- **Long tool life through the reduction of tool paths**
- **Good combination with heat-resistant grade PR1535 provides long tool life and stable machining**

## 2

# Available for a Variety of Machining Applications and Environments

## 1 Solutions for 90° End Mills (Rough to Medium-Finish Machining)

### High Feed Rates Dramatically Improve Machining Efficiency

#### Machining Efficiency Simulation Example

Pocketing: Vc = 150 m/min, ae = 12.5 mm

**MFH Boost**  
 ø 25 (3 Inserts) **100 cc/min**  
 ap = 2.0 mm, fz = 0.7 mm/t

Machining Efficiency  
 ↑  
 x 1.8

Conventional 90° End Mill  
 ø 25 (3 Inserts) **54 cc/min**  
 ap = 5.0 mm, fz = 0.15 mm/t

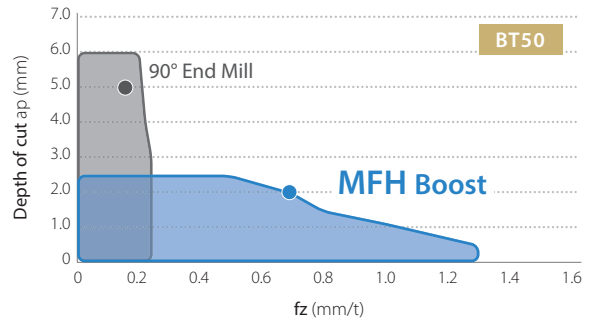

### High Efficiency and Good Tool Life

#### Machining Efficiency and Cutting Edge Condition Comparison (Internal evaluation)

##### Cutting edge condition after 100 min machining

**MFH Boost**  
 ap = 1.6 mm, fz = 0.6 mm/t

Competitor A 90° End Mill  
 ap = 5.0 mm, fz = 0.15 mm/t

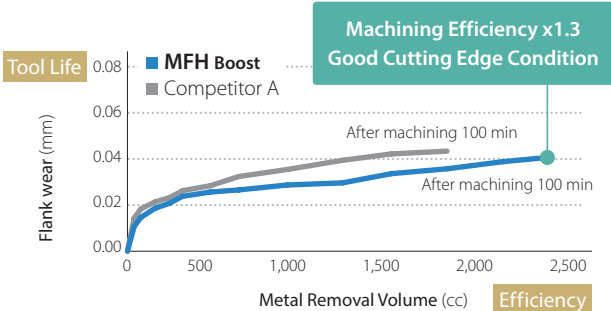

Vc = 150 m/min, ae = 12.5 mm, Dry SCM440(®) ø 25 (1 Insert) BT50

### High Stability in Unstable Machining Environment

#### Chatter Resistance Comparison (Internal evaluation)

Slotting  
 ø 25 (3 Inserts)  
 External air  
 S50C  
 BT50

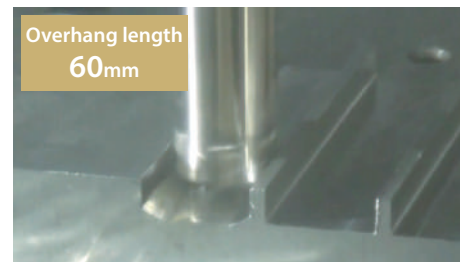

#### Video



#### Machining Efficiency

**MFH Boost** **103 cc/min**  
 Vc = 120 m/min, ap = 1.5 mm, fz = 0.6 mm/t

Machining Efficiency  
 ↑  
 x 4.5

**31 cc/min Chattering (Machining was impossible)**  
 Competitor A  
 90° End Mill  
**23 cc/min**  
 Vc = 80 m/min, ap = 2 mm, fz = 0.2 mm/t

### High Efficiency and Stable Machining Designs

#### Kyocera's original technology

Convex cutting edge design reduces impact when entering workpiece

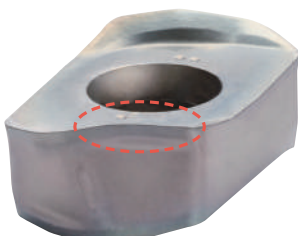

#### Cutting Force when Entering Workpiece (Internal evaluation)

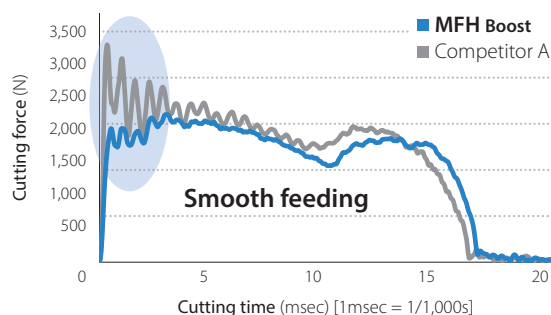

Vc = 150 m/min, ap = 2.0 mm, ae = 25 mm, fz = 0.7 mm/t, Dry S50C ø 50 (1 Insert) BT50



## 2 Better Solution to Conventional High Feed Cutters

### Large D.O.C. Dramatically Improves Machining Efficiency

#### Machining Efficiency Simulation Example

Multistage Machining (Depth 30 mm); Vc = 150 m/min, ae = 12.5 mm

**MFH Boost**  
 ø 25 (3 Inserts)  
**100 cc/min**  
 ap = 2.0 mm, fz = 0.7 mm/t

Machining Efficiency  
 x 1.3

Conventional high feed cutter  
 ø 25 (3 Inserts)  
**76 cc/min**  
 ap = 1.0 mm, fz = 0.8 mm/t

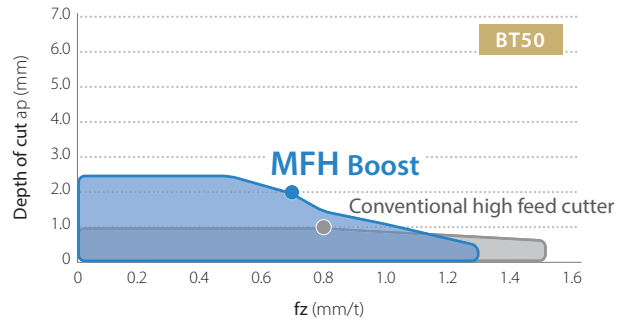

### High Efficiency and Good Tool Life

#### Machining Efficiency and Cutting Edge Condition Comparison (Internal evaluation)

##### Cutting edge condition after 100 min machining

**MFH Boost**  
 ap = 1.6 mm, fz = 0.6 mm/t



Competitor B High Feed Type  
 ap = 0.8 mm, fz = 0.6 mm/t

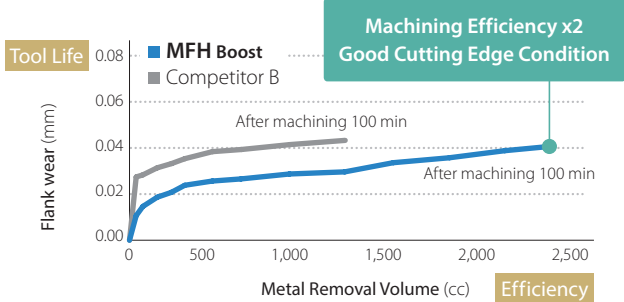

Vc = 150 m/min, ae = 12.5 mm, Dry SCM440 ø 25 (1 Insert) BT50

### Excellent Wall Accuracy

Video



#### Machining Efficiency and Wall Accuracy Comparison (Internal Evaluation)

Pocketing (Depth 12mm)

**MFH Boost**  
 ø 25 (3 Inserts)

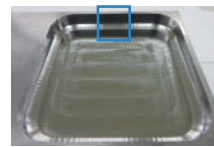

ap = 1.5 mm × 8 Passes  
 Q = 115 cc/min

Competitor B High Feed Type  
 ø 25 (4 Inserts)



ap = 0.8 mm × 15 Passes  
 Q = 81 cc/min

Cutting Conditions: Vc = 200 m/min, ae = 12.5 mm, fz = 0.8 mm/t, Dry S50C BT50

### Superior Wall Accuracy



Wiper on outer periphery

Reduction of wall level variation in multi-pass machining

## 3 Solutions for Machining Difficult-to-cut Materials

### Dramatic improvement in machining efficiency with titanium alloy, stainless steel machining, etc.

#### Machining Efficiency Comparison (Internal evaluation)

Titanium Alloy Pocketing (Depth 6 mm)

**MFH Boost**  
**Approx. 1' 30"**  
 ap = 1.5 mm × 4 Passes (fz = ~0.35 mm/t)

Machining Efficiency  
 x 1.8

Competitor C High Feed Type  
**Approx. 2' 50"**  
 ap = 0.6 mm × 10 Passes (fz = ~0.4 mm/t)

Vc = 50 m/min, ae = 12.5 mm (ae/DCX = 50%), Ramping angle 3° Ti-6Al-4V Wet ø25 (3 inserts) BT50

Video

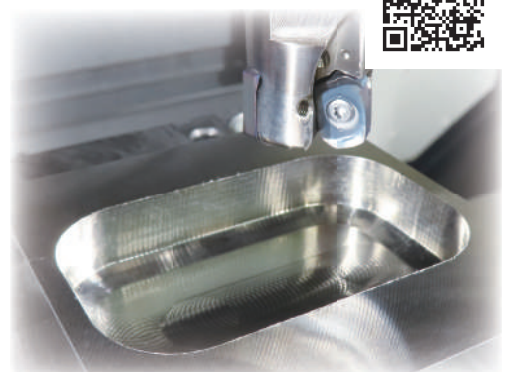

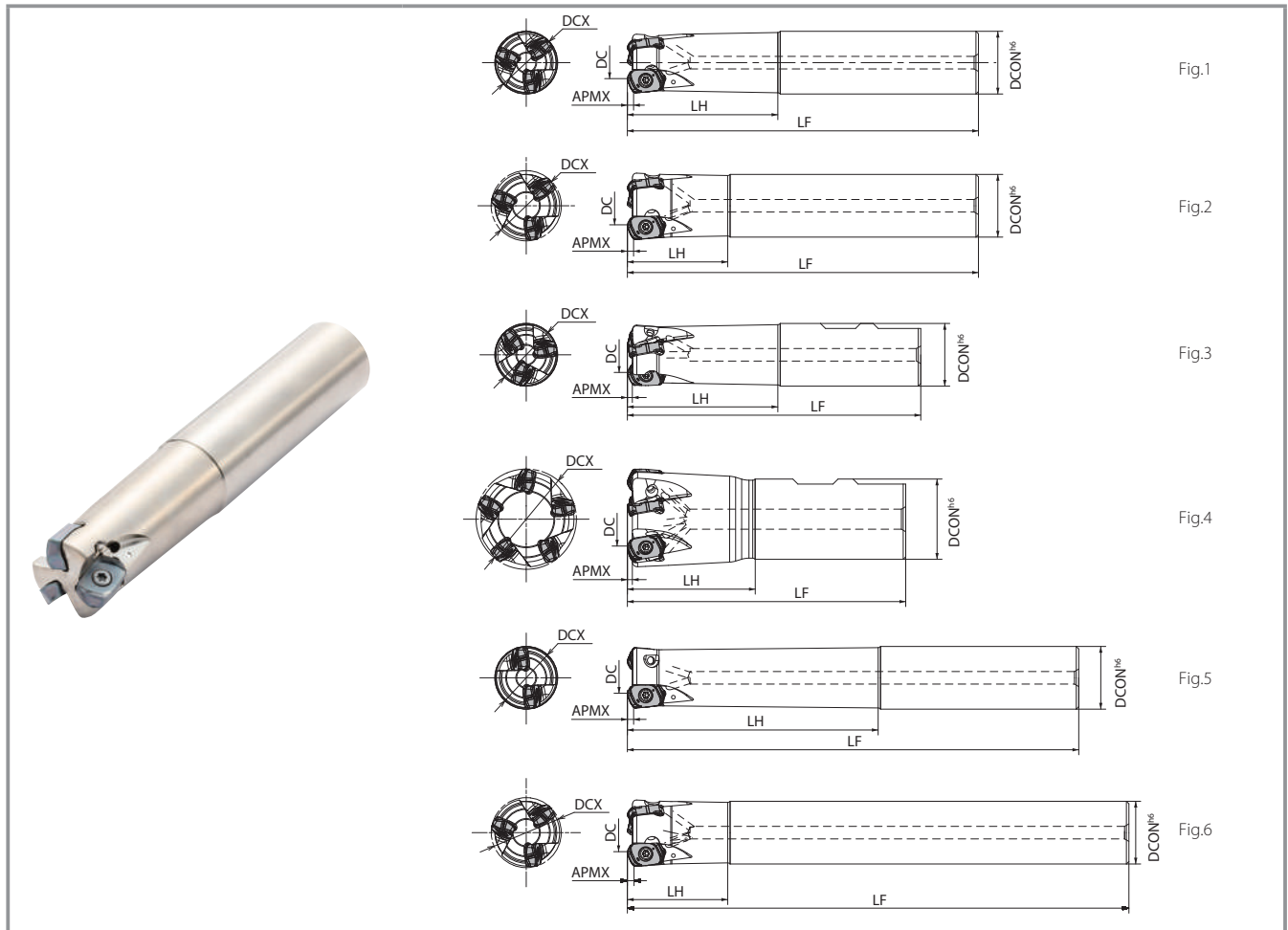

Toolholder Dimensions

Shank	Description	Stock	No. of Inserts	Dimensions (mm)						Rake Angle		Coolant Hole	Shape	Weight (kg)	Max.Revolution (min <sup>-1</sup> )
				DCX	DC	DCON	LH	LF	APMX	A.R.					
Standard (Straight)	MFH 25-S25-04-2T	●	2	25	14	25	60	140	2.5	-10°	Yes	Fig.1	0.5	12,700	
	25-S25-04-3T	●	3										0.5		
	32-S32-04-4T	●	4	32	21	32	70	150					0.8		11,200
	32-S32-04-5T	●	5										0.8		
Over Size (Straight)	MFH 22-S20-04-2T	●	2	22	11	20	30	130	2.5	-10°	Yes	Fig.2	0.3	13,600	
	28-S25-04-3T	●	3	28	17	25	40	140					0.5		
	28-S25-04-4T	●	4										35	24	32
	35-S32-04-4T	●	4	35	24	32	50	150							
	35-S32-04-5T	●	5										40	29	32
	40-S32-04-5T	●	5	40	29	32	50	150							
	40-S32-04-6T	●	6										0.9	10,000	
Standard (Weldon)	MFH 25-W25-04-2T	●	2	25	14	25	60	117	2.5	-10°	Yes	Fig.3	0.4	12,700	
	25-W25-04-3T	●	3										0.4		
	32-W32-04-4T	●	4	32	21	32	70	131					0.7	11,200	
	32-W32-04-5T	●	5										0.7		
	40-W32-04-5T	●	5	40	29	32	50	111					0.7	10,000	
	40-W32-04-6T	●	6										0.7		
Long Shank (Straight)	MFH 25-S25-04-2T-180	●	2	25	14	25	100	180	2.5	-10°	Yes	Fig.5	0.6	12,700	
	25-S25-04-3T-180	●	3										0.6		
	28-S25-04-3T-200	●	3	28	17	32	40	200					0.7	12,000	
	32-S32-04-4T-200	●	4										0.7		
	32-S32-04-4T-200	●	4	32	21	32	120	200					1.1	11,200	
	35-S32-04-4T-200	●	4										1.1		
	35-S32-04-4T-200	●	4	35	24	32	50	250					1.1	10,700	
40-S32-04-5T-250	●	5	1.5						10,000						

Caution with Max. Revolution

Set the number of revolutions per minute within the recommended cutting speed specified by the workpiece on back cover.

Do not use the end mill or cutter at the maximum revolution or higher since the centrifugal force may cause chips and parts to scatter even under no load.

● : Standard Stock

# MFH Boost Face Mill

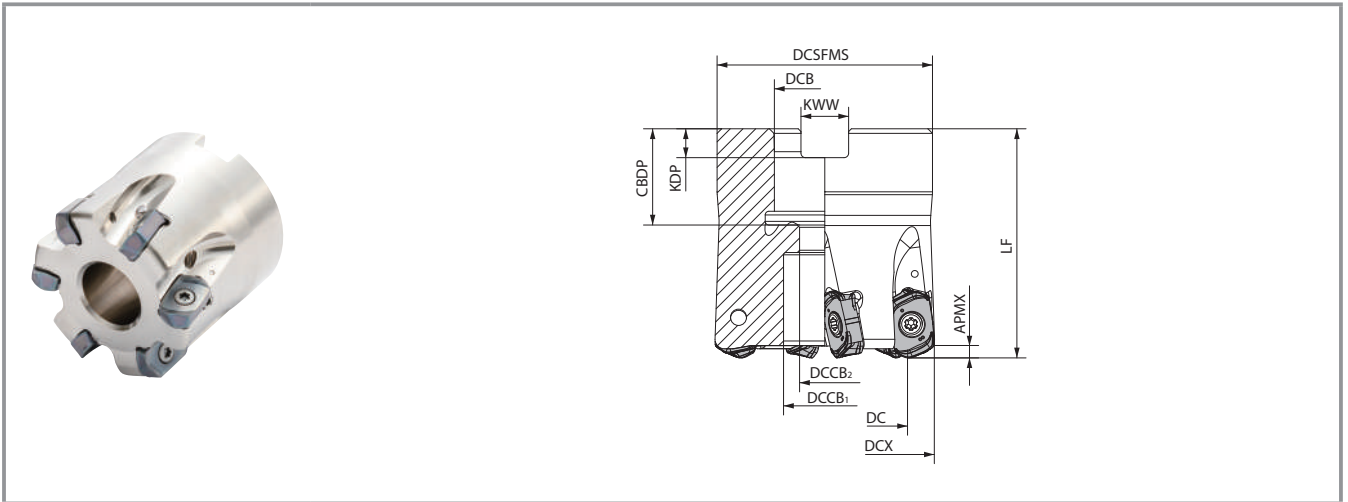

## Toolholder Dimensions

Bore Dia.	Description	Stock	No. of Inserts	Dimensions (mm)												Rake Angle	Coolant Hole	Weight (kg)	Max.Revolution (min <sup>-1</sup> )
				DCX	DC	DCSFMS	DCB	DCCB <sub>1</sub>	DCCB <sub>2</sub>	LF	CBDP	KDP	KWW	APMX	A.R.				
Inch Spec	MFH 080R-04-8T	●	8	80	69	76	31.75	26	17	63	32	8.0	12.7	2.5	-10°	Yes	1.6	7,100	
	MFH 080R-04-10T	●	10														1.6		
Metric Spec	MFH 040R-04-5T-M	●	5	40	29	38	16	15	9	40	19	5.6	8.4					0.2	10,000
	MFH 040R-04-6T-M	●	6															0.2	
	MFH 050R-04-6T-M	●	6	50	39	47												0.4	9,000
	MFH 050R-04-7T-M	●																7	
	MFH 052R-04-6T-M	●	6	52	41	47	22	18	11									0.5	8,800
	MFH 052R-04-7T-M	●																7	
	MFH 063R-04-7T-M	●	7							50								0.8	8,000
	MFH 063R-04-9T-M	●																9	
	MFH 063R-04-7T-27M	●	7	63	52	60												0.8	8,000
	MFH 063R-04-9T-27M	●																9	
	MFH 080R-04-8T-M	●	8	80	69	76					63							1.8	7,100
	MFH 080R-04-10T-M	●	10															1.7	



Caution with Max. Revolution

Set the number of revolutions per minute within the recommended cutting speed specified by the workpiece on back cover.

Do not use the end mill or cutter at the maximum revolution or higher since the centrifugal force may cause chips and parts to scatter even under no load.

● : Standard Stock

## Parts

Description	Parts		
	Clamp Screw	Wrench	Anti-seize Compound
			
MFH ...-04...	SB-3575TRP	DTPM-10	P-37
Recommended Torque for Insert Clamp 2.0N · m			

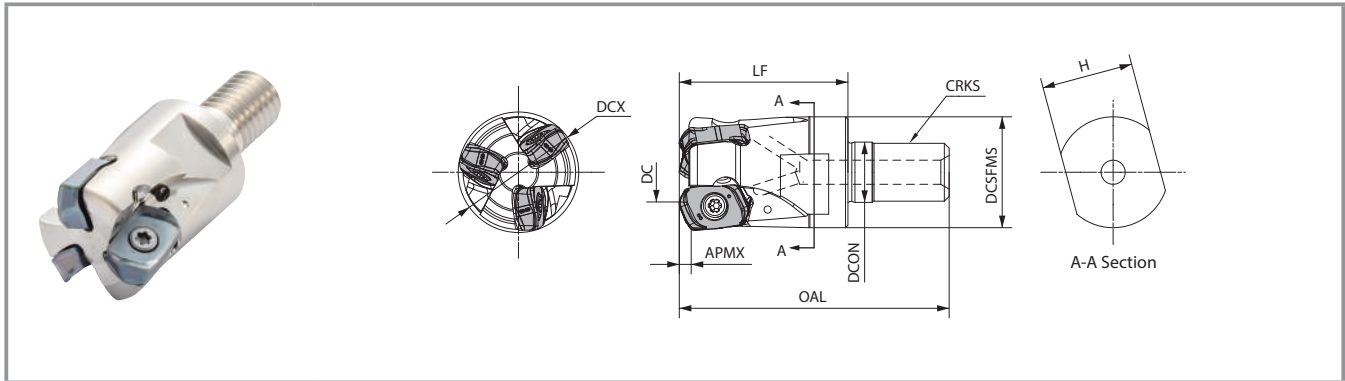

Toolholder Dimensions

Description	Stock	No. of Inserts	Dimensions (mm)								Rake Angle		Coolant Hole	Max.Revolution (min <sup>-1</sup> )						
			DCX	DC	DCSFMS	DCON	OAL	LF	CRKS	H	APMX	A.R.								
MFH 22-M10-04-2T	●	2	22	11	18.7	10.5	48	30	M10XP1.5	15	2.5	-10°	Yes	13,600						
25-M12-04-2T	●		25	14	23	12.5	56	35	M12XP1.75	19				12,700						
25-M12-04-3T	●	3	28	17										30	17	62	40	M16XP2.0	24	12,000
28-M12-04-3T	●				4	32	21	35	M16XP2.0	24										10,000
28-M12-04-4T	●																			
32-M16-04-4T	●	4	35	24	30	17	62	40	M16XP2.0	24										11,200
32-M16-04-5T	●																			
35-M16-04-4T	●	6	42	31	30	17	62	40	M16XP2.0	24										10,000
35-M16-04-5T	●																			
40-M16-04-5T	●	6	42	31	30	17	62	40	M16XP2.0	24										9,800
40-M16-04-6T	●																			
42-M16-04-5T	●	6	42	31	30	17	62	40	M16XP2.0	24										9,800
42-M16-04-6T	●										5	42	31							

Caution with Max. Revolution

Set the number of revolutions per minute within the recommended cutting speed specified by the workpiece on back cover.

Do not use the end mill or cutter at the maximum revolution or higher since the centrifugal force may cause chips and parts to scatter even under no load.

● : Standard Stock

Applicable Inserts

Shape	Description	Dimensions (mm)					MEGACOAT NANO			CVD Coating
		W1	S	D1	INSL	RE	PR1535	PR1525	PR1510	CA6535
<p>4-edge, Double-sided insert</p>	LOMU 040410ER-GM	9.1	4.4	4.1	14.5	1.0	●	●	●	●

● : Standard Stock

Insert Grade:

**PR1535** For Steel Machining (Stable machining oriented), Titanium alloy, Austenitic/Precipitation hardening stainless steel, etc.

**PR1525** For Steel Machining (General use)

**PR1510** For Cast Iron Machining

**CA6535** For Martensitic stainless steel, Ni-base heat resistant alloy, etc.



# BT Arbor (for exchangeable head/two face contact)

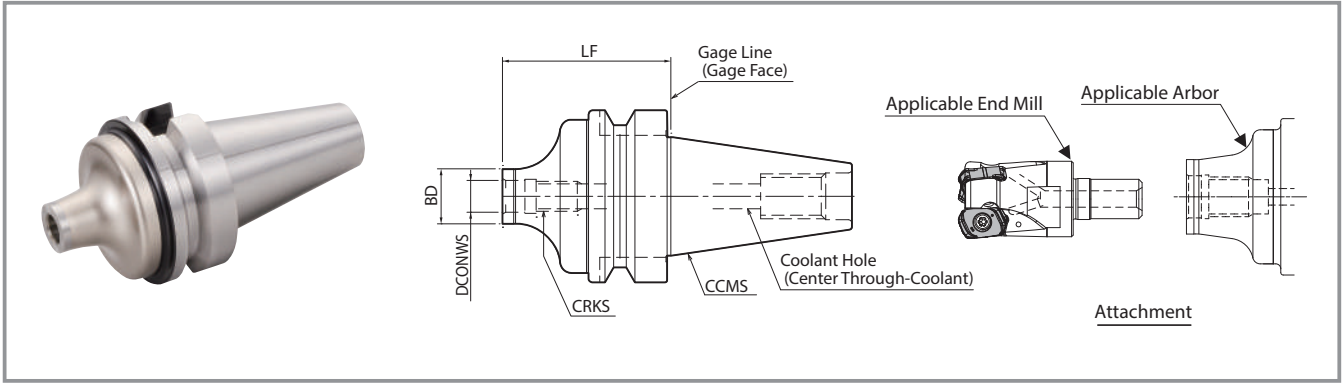

## Dimension

Description	Stock	Dimensions (mm)				Coolant Hole	Arbor (Two-face clamping)	Applicable End Mill (Head)
		LF	BD	DCONWS	CRKS		CCMS	
BT30K- M10-45	●	45	18.7	10.5	M10×P1.5	Yes	BT30	MFH...M10-...
M12-45	●	45	23	12.5	M12×P1.75			MFH...M12-...
BT40K- M10-60	●	60	18.7	10.5	M10×P1.5	Yes	BT40	MFH...M10-...
M12-55	●	55	23	12.5	M12×P1.75			MFH...M12-...
M16-65	●	65	30	17	M16×P2.0			MFH...M16-...

● : Standard Stock

## Actual End Mill Depth

Arbor Description	Applicable End Mill (Head)			Actual End Mill Depth(mm)
	Description	Cutting Dia.(mm)	Dimension(mm)	LUX
			DC	
BT30K- M10-45	MFH22-M10...	22	30	39.2
	MFH25-M12...	25	35	42.8
	MFH28-M12...	28	35	45.5
BT40K- M10-60	MFH22-M10...	22	30	44.5
	MFH25-M12...	25	35	44.6
	MFH28-M12...	28	35	47.6
M16-65	MFH32-M16...	32	40	51.2
	MFH35-M16...	35	40	60.2
	MFH40-M16...	40	40	64.0
	MFH42-M16...	42	40	64.0

## MFH Series Large Lineup for Various Applications and Machining Environments

Small Diameter/  
Large Depth of Cut



Micro Diameter



Small Diameter/  
Fine Pitch Type



Large Diameter

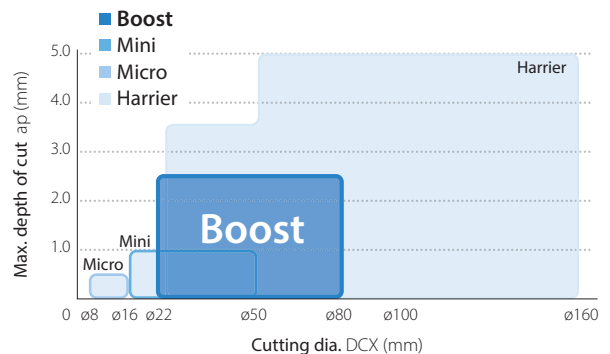

## Recommended Cutting Conditions ★ 1st recommendation ☆ 2nd recommendation

Chipbreaker	Workpiece	Toolholder Description and Feed (fz: mm/t)		Recommended Insert Grade (Vc: m/min)			
		ap(mm)	MFH...04...	MEGACOAT NANO			CVD Coating
				PR1535	PR1525	PR1510	CA6535
GM	Carbon Steel (SxxC) (~ 280HB)	≤ 0.5	0.20 - <b>0.80</b> - 1.30	120 - <b>160</b> - 220	120 - <b>160</b> - 220	-	-
		≤ 1.0	0.20 - <b>0.70</b> - 1.10				
		≤ 1.5	0.20 - <b>0.60</b> - 0.80				
		≤ 2.0	0.20 - <b>0.40</b> - 0.70				
		≤ 2.5	0.20 - <b>0.30</b> - 0.50				
	Alloy Steel (SCM, etc.) (~ 350HB)	≤ 0.5	0.20 - <b>0.75</b> - 1.20	100 - <b>150</b> - 200 (Dry Machining Recommended)	100 - <b>150</b> - 200 (Dry Machining Recommended)	-	-
		≤ 1.0	0.20 - <b>0.65</b> - 1.00				
		≤ 1.5	0.20 - <b>0.55</b> - 0.70				
		≤ 2.0	0.20 - <b>0.40</b> - 0.55				
		≤ 2.5	0.20 - <b>0.25</b> - 0.35				
	Mold Steel (SKD, etc.) (~ 40HRC)	≤ 0.5	0.20 - <b>0.60</b> - 1.10	80 - <b>120</b> - 160 (Dry Machining Recommended)	80 - <b>120</b> - 160 (Dry Machining Recommended)	-	-
		≤ 1.0	0.20 - <b>0.50</b> - 0.90				
		≤ 1.5	0.20 - <b>0.40</b> - 0.65				
		≤ 2.0	0.20 - <b>0.30</b> - 0.55				
		≤ 2.5	0.20 - <b>0.25</b> - 0.35				
	Mold Steel (SKD, etc.) (40 ~ 50HRC)	≤ 0.5	0.10 - <b>0.30</b> - 0.50	-	60 - <b>100</b> - 130 (Dry Machining Recommended)	-	-
		≤ 1.0	0.10 - <b>0.25</b> - 0.40				
		≤ 1.5	0.10 - <b>0.20</b> - 0.30				
		≤ 2.0	-				
	Mold Steel (SKD, etc.) (50 ~ 55HRC)	≤ 0.5	0.10 - <b>0.20</b> - 0.40	-	50 - <b>70</b> - 100 (Dry Machining Recommended)	-	-
		≤ 1.0	0.10 - <b>0.15</b> - 0.25				
		≤ 1.5	-				
		≤ 2.0	-				
	Austenitic Stainless Steel (SUS304, etc.)	≤ 0.5	0.20 - <b>0.60</b> - 1.00	100 - <b>140</b> - 180	100 - <b>140</b> - 180	-	-
		≤ 1.0	0.20 - <b>0.50</b> - 0.90				
		≤ 1.5	0.20 - <b>0.45</b> - 0.60				
		≤ 2.0	0.20 - <b>0.30</b> - 0.50				
		≤ 2.5	0.20 - <b>0.25</b> - 0.40				
	Martensitic Stainless Steel (SUS403, etc.)	≤ 0.5	0.20 - <b>0.60</b> - 1.00	100 - <b>150</b> - 200	-	-	150 - <b>200</b> - 300
		≤ 1.0	0.20 - <b>0.50</b> - 0.90				
		≤ 1.5	0.20 - <b>0.45</b> - 0.60				
		≤ 2.0	0.20 - <b>0.30</b> - 0.50				
		≤ 2.5	0.20 - <b>0.25</b> - 0.40				
	Precipitation Hardened Stainless Steel (SUS630, etc.)	≤ 0.5	0.10 - <b>0.30</b> - 0.50	90 - <b>120</b> - 150	-	-	-
		≤ 1.0	0.10 - <b>0.25</b> - 0.45				
		≤ 1.5	0.10 - <b>0.15</b> - 0.25				
≤ 2.0		-					
Gray Cast Iron (FC)	≤ 0.5	0.20 - <b>0.80</b> - 1.30	-	-	120 - <b>160</b> - 220	-	
	≤ 1.0	0.20 - <b>0.70</b> - 1.10					
	≤ 1.5	0.20 - <b>0.60</b> - 0.80					
	≤ 2.0	0.20 - <b>0.40</b> - 0.70					
	≤ 2.5	0.20 - <b>0.30</b> - 0.50					
Nodular Cast Iron (FCD)	≤ 0.5	0.20 - <b>0.60</b> - 1.00	-	-	100 - <b>150</b> - 200	-	
	≤ 1.0	0.20 - <b>0.50</b> - 0.90					
	≤ 1.5	0.20 - <b>0.40</b> - 0.70					
	≤ 2.0	0.20 - <b>0.30</b> - 0.60					
Ni-base Heat-Resistant Alloy	≤ 0.5	0.10 - <b>0.30</b> - 0.45	20 - <b>30</b> - 50	-	-	20 - <b>30</b> - 50	
	≤ 1.0	0.10 - <b>0.25</b> - 0.40					
	≤ 1.5	0.10 - <b>0.15</b> - 0.20					
	≤ 2.0	-					
Titanium Alloy (Ti-6Al-4V)	≤ 0.5	0.10 - <b>0.30</b> - 0.50	40 - <b>60</b> - 80	-	-	-	
	≤ 1.0	0.10 - <b>0.25</b> - 0.45					
	≤ 1.5	0.10 - <b>0.15</b> - 0.25					
	≤ 2.0	-					
		≤ 2.5	-				

- The number in **bold font** is recommended starting conditions. Adjust the cutting speed and the feed rate within the above conditions according to the actual machining situation.
- Machining with coolant is recommended for Precipitation Hardened Stainless Steel, Ni-base Heat-Resistant Alloy and Titanium Alloy.
- Wet machining may have a lower tool life than dry machining. Set the cutting speed, feed rate and D.O.C. lower than recommended conditions.
- Machining with BT30 or equivalent, feed rate should be reduced to 25% of recommended cutting conditions. Slotting is not recommended.
- Center through air is recommended for slotting.
- Slotting or pocketing are not recommended for face mill type.
- For face milling, it is recommended that width of cut should be set to 75% or less of the cutting diameter.
- It is recommended to set the long shank to 75% or less of the recommended conditions for both ap and feed.

## Precautions

### Approximate Programming Radius Adjustment

Shape	Programmable R (mm)	Over Machined Radius Portion (mm)	Non-machined Portion (mm)
	1.5	0	1.42
	2.0	0	1.24
	3.0 (Recommended)	0	0.87
	3.5	0.06	0.69

### Ramping Tips

- Ramping angle should be under RMPX
- Reduce recommended feed rate in cutting conditions above by 70%

Formula for Max. Cutting Length (L) at Max. Ramping Angle

$$L = \frac{ap}{\tan RMPX}$$

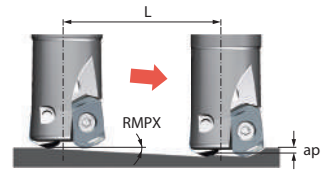

- When ramping from both the front and outer periphery, set the maximum ramping angle RMPX to 50%.

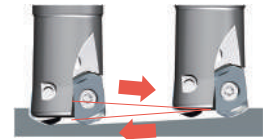

### Ramping Reference Table

Description	Cutter Dia. DCX (mm)	22	25	28	32	35	40	42	50	52	63	80
MFH...-04- ...	Max. Ramping Angle RMPX	3.9°	3.0°	2.4°	2.0°	1.7°	1.4°	1.3°	1.0°	1.0°	0.8°	0.6°
	tan RMPX	0.068	0.052	0.042	0.035	0.029	0.024	0.022	0.018	0.017	0.013	0.010

### Helical Milling Tips

- For helical milling, use between min. cutting dia. and max. cutting dia.

#### Exceeding Max. Machining Dia.

Center Core Remains After Machining



#### Under Min. Machining Dia.

Center Core Hits Holder Body

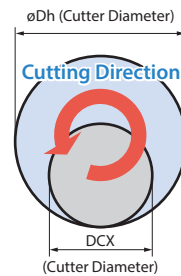

Description	Min. Cutting Dia. (mm)	Max. Cutting Dia. (mm)
MFH...-04- ...	2×DCX-11	2×DCX-2

- Maximum ramping depth per cycle to be under maximum D.O.C. ap (2.5 mm)
- Use climb milling. (Refer to the above figure)
- Feed rates should be reduced to 50% of recommended cutting conditions
- Use caution to eliminate incidences caused by producing long chips

### Drilling Tips

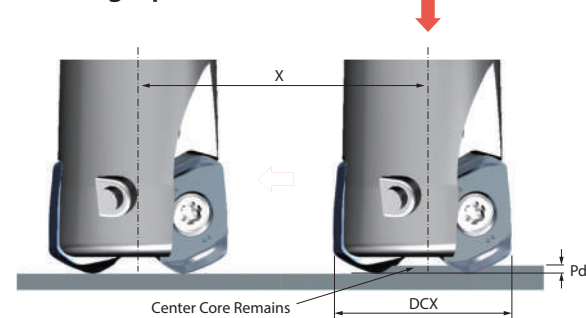

Description	GM Type	
	Max. Drilling Depth Pd (mm)	Min. Cutting Length X for Flat Bottom Surface (mm)
MFH...-04- ...	0.6	DCX-12

- It is recommended to reduce feed by 25% of recommendation until the center core is removed
- Axial feed rate recommendation per revolution is  $f \leq 0.2\text{mm/rev}$

### Plunging

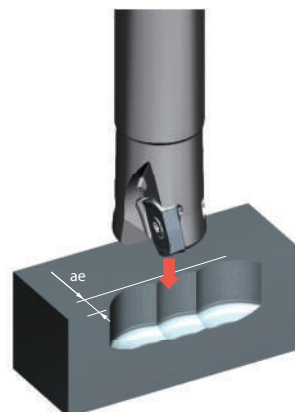

Insert Description	Maximum Width of Cut (ae)
LOMU04 Type	5.0mm

- Reduce feed rate to  $f_z \leq 0.2\text{mm/t}$  when plunging

# Fast, Strong, and Efficient

**Valve Parts SCM 440**  $V_c = 180 \text{ m/min}$ ,  $a_p \times a_e = 1.5 \times 32 \text{ mm}$ ,  $f_z = 0.35 \text{ mm/t}$ , BT50

**Helical Milling**  
4 - Ø 60 (Depth 80 mm)

<b>MFH Boost</b> ø 32 (4 Inserts)	<b>Q = 132 cc/min</b>	Machining Efficiency <b>x 3.5</b>
Conventional A High Feed Type ø 32 (3 Inserts)	<b>Q = 38 cc/min</b>	

The MFH Boost achieved 3.2 times machining efficiency **by increasing the D.O.C. and number of inserts.**  
Even with 90mm overhang portion,  $a_p = 1.5 \text{ mm}$  large D.O.C. machining is possible.

**Industrial Parts S50C**  $V_c = 150 \text{ m/min}$ ,  $a_p \times a_e = 1.0 \times \sim 20 \text{ mm}$ ,  $f_z = 0.36 \text{ mm/t}$ , BT40

**Slotting Shouldering**

<b>MFH Boost</b> ø 25 (3 Inserts)	<b>Q = 42 cc/min</b>	Machining Efficiency <b>x 3.2</b>
Competitor D 90° End Mill ø 25 (2 Inserts)	<b>Q = 13 cc/min</b>	

The MFH Boost achieved 3.2 times machining efficiency **by increasing cutting speed, feed, and number of inserts.**  
There is no problem with the value of the load meter when increasing to the cutting conditions above.

**Mold Parts Prehardened steel**  $V_c = 120 \text{ m/min}$ ,  $a_p \times a_e = 1.5 \times 30 \text{ mm}$ ,  $f_z = 0.7 \text{ mm/t}$ , Internal air

**Mold Parts Prehardened steel**

<b>MFH Boost</b> ø 50 (7 Inserts)	<b>Q = 192 cc/min</b>	Machining Efficiency <b>x 1.4</b>
Competitor E High Feed Type ø 50 (7 Inserts)	<b>Q = 140 cc/min</b>	

The MFH Boost provides a low cutting forces **even when the feed and  $a_p$  are increased.** and achieves a machining efficiency 1.4 times.  
Even when machining where the depth of cut is doubled, distortion is equivalent to competitor E.

(User Evaluation)