

High Precision and High Efficiency High Rake Cutter

MFSE45



SUS304 0.46 μ mRa

Rough and Finish in 1 Pass with Excellent Surface Finish

Roughing Condition ($f_z = 0.25$ mm/t) Provides Excellent Surface Finish (0.8 μ mRa or Less) *

Maintains Long Tool Life with High-Precision Inserts

Newly Developed Chipbreakers for Steel, Stainless Steel, and Aluminum

Improved Productivity with Excellent Chip Control



*Based on internal evaluation with wiper insert installed.

High Precision and High Efficiency High Rake Cutter

MFSE45

Rough and Finish in 1 Pass with Excellent Surface Finish

Roughing Condition ($fz = 0.25 \text{ mm/t}$) Provides Excellent Surface Finish ($0.8 \mu\text{mRa}$ or Less) *

1 The MFSE45 Milling Solution

Delivers high-quality surfaces by roughing and finishing simultaneously

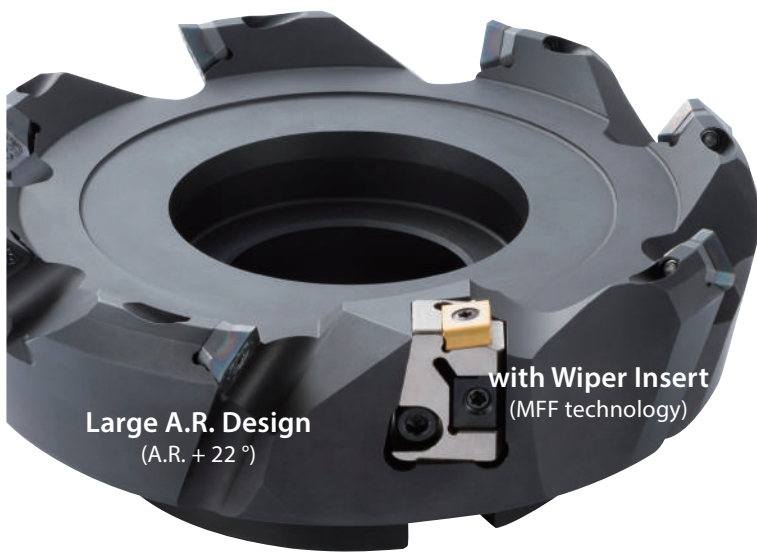

MFSE45 (VALUE)

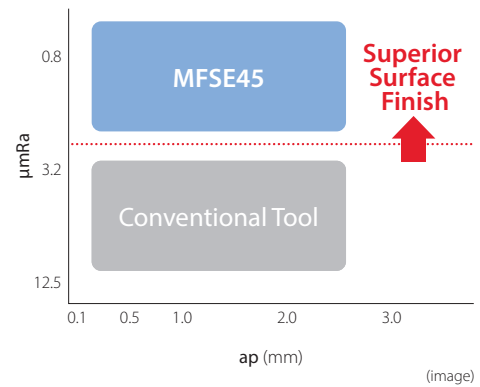

Machining Comparison Simulation (Example)

MFSE45 1 Pass and cutting time was cut by 1/3, with a good surface finish ($0.8 \mu\text{mRa}$ or less)

$fz = 0.25 \text{ mm/t}$ ($ap = 1.0 \text{ mm}$)

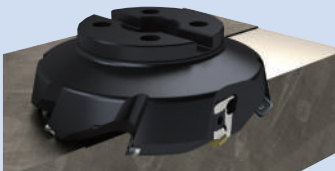

Cutting Time **Roughing + Finishing**

Cutting Conditions: $Vc = 300 \text{ m/min}$, Dry S50C (Internal evaluation)

0.24µmRa



SOLUTION

1 Pass

Time = 1/3

Surface Finish ✓

Conventional Machining

Two separate passes for roughing and finishing. Cutting time is longer due to low feed rates during finishing

$fz = 0.15 \text{ mm/t}$ ($ap = 0.8 \text{ mm}$)

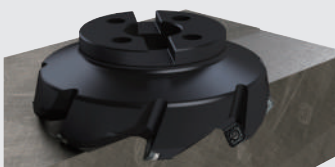

Cutting Time **Roughing**

$fz = 0.125 \text{ mm/t}$ ($ap = 0.2 \text{ mm}$)



Finishing

CG image

2 Beautiful Surface Finish and Long Tool Life

Strict control of insert inscribed circle tolerance
 Improved surface finish quality and longer tool life
 with reducing front edge runout

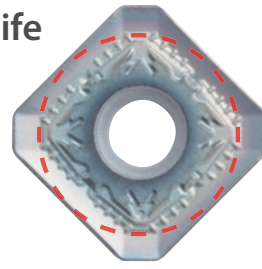

Inscribed Circle Tolerance
 ± 0.015 mm or Less
 (Class E Standard ± 0.025 mm or less)

Excellent Front Edge Runout Accuracy

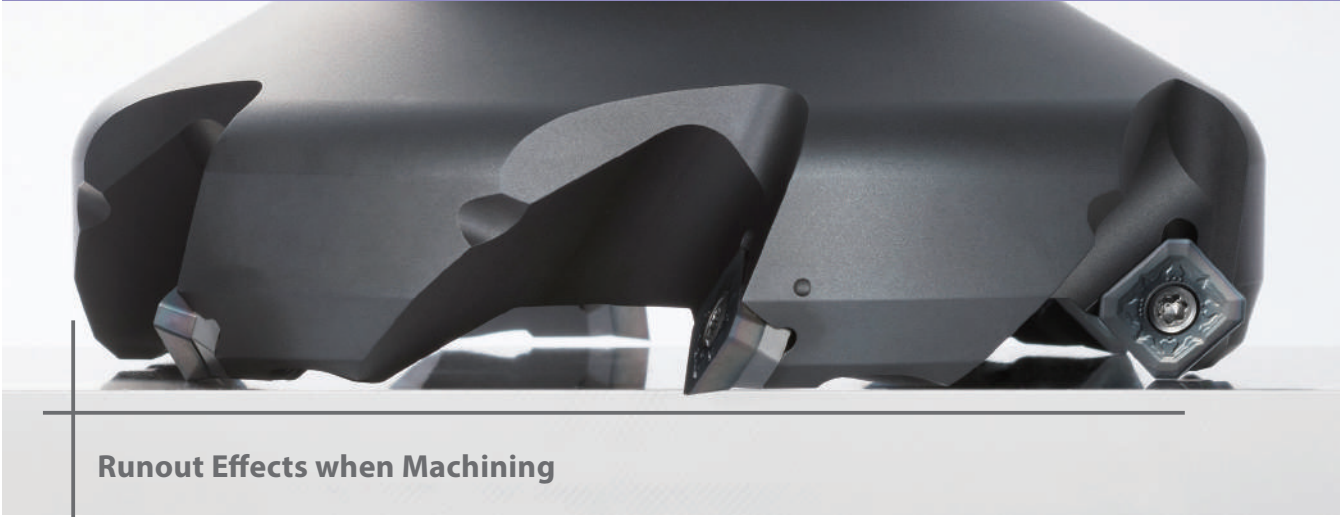

Advantage ① Theoretical reduction of roughness on finished surface, excellent surface roughness

Effect on surface finish
 (Image)

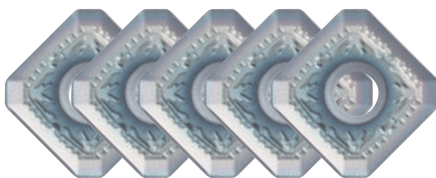

Front Edge Runout: Small \Rightarrow
 Surface Roughness: Good

Surface roughness in stainless steel machining (Internal evaluation)

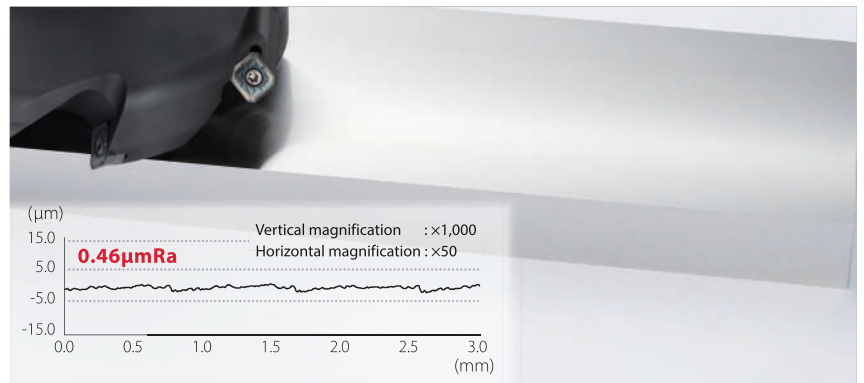

Cutting Conditions : $V_c = 250$ m/min, $a_p \times a_e = 1.0 \times 100$ mm, $f_z = 0.15$ mm/t, Wet SUS 304 $\phi 125$ (Standard 6 inserts) SL Chipbreaker

Advantage ② Insert wear progresses evenly and tool life can be improved

Effect on wear (User evaluation)

	Average corner examples	Heavily damaged corner examples	
MFSE45	Wear: 0.145mm	Wear: 0.172mm	Variation : Small
Competitor A	Wear: 0.105mm	Wear: 0.911mm	Variation : Large

Cutting Conditions : $V_c = 270$ m/min, $a_p = \sim 1.5$ mm, $f_z = 0.2$ mm/t, Wet SS 400 $\phi 250$ (15 inserts) SL Chipbreaker (PR1535)

Due to the high wear rate of the insert, all inserts need to be replaced, which may result in shorter tool life.

3

Kyocera's Newly Developed Unique Molded Chipbreaker

Excellent chip control. Eliminates chip entanglement in jigs, etc. and improves work efficiency

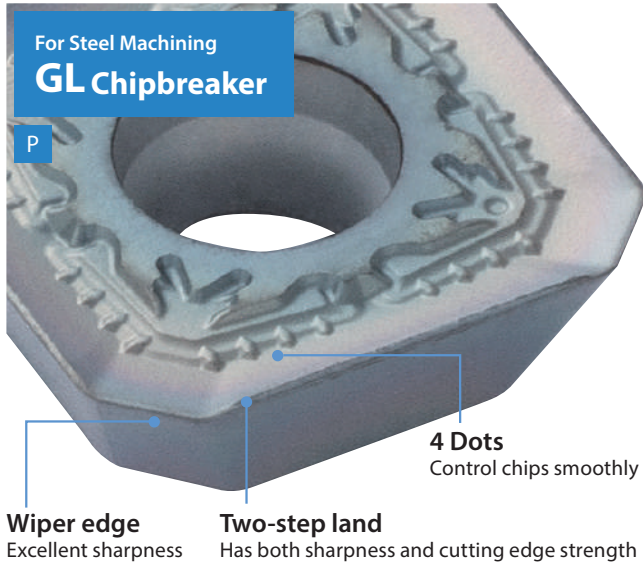

Delivers excellent chip evacuation, sharpness, strength and machining accuracy

Chip control and cutting edge condition comparison (Internal evaluation)

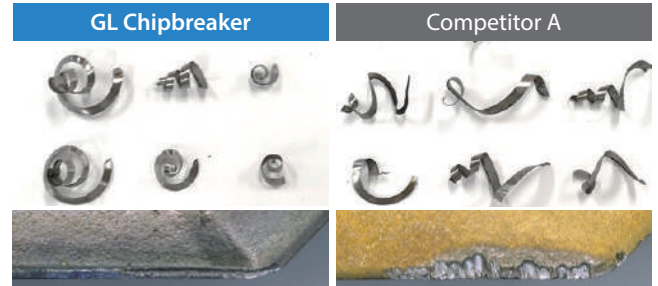

Cutting Conditions : Vc = 300 m/min , ap = 1.0-1.5 mm , fz = 0.2 mm/t SS400 ø 100 (15 Flutes)

For Stainless Steel and Aluminum Machining are available

For Stainless Steel Machining
SL Chipbreaker

M
Micro-honing



For Aluminum Machining
AL Chipbreaker

N
Sharp Edge

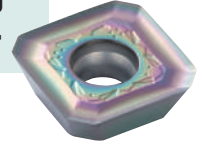

4

Various Holders Available for Multiple Applications

In addition to styles with a wiper insert, the standard type with only the standard inserts are also available

Toolholder Specifications

Type	With Wiper Insert	Standard
Surface roughness	Approx. 0.8 μ mRa	Approx. 1.6 μ mRa
Recommended feed	fz = 0.25 mm/t	fz = 0.12 mm/t (Finish machining time)
Application	High efficiency finishing	General purpose (Uses 1 insert style)

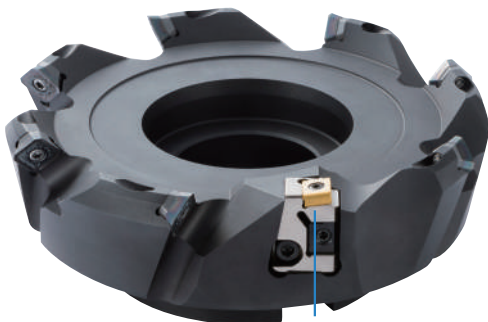

Using wiper insert for MFF
(Cutting edge adjustment mechanism with excellent operability)

Note) See page 6 for details on how to adjust the cutting edge.



*Standard type only (Bore Dia. inch spec, ø 160 ~)

MFSE45 Delivers Excellent Results

*Based on internal evaluation

Surface Finish

SUS 304 / Excellent Surface Finish

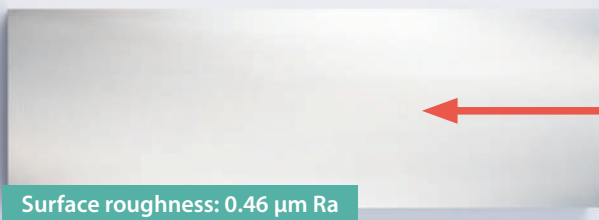

Surface roughness: 0.46 $\mu\text{m Ra}$

$\phi 125$
SEET13T3AGSN-SL PR1535
 $V_c = 250 \text{ m/min}$, $a_p = 0.2 \text{ mm}$
 $f_z = 0.15 \text{ mm/t}$, SUS304 Wet BT50

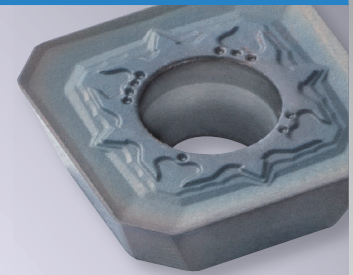

Excellent glossy finish even under high feed rates machining stainless steel

*User evaluation

Burrs and Chips

SS400 Rail / Reduced Machining Down-time



CG image

$\phi 100$ (Left hand)
SEET13T3AGSN-GL PR1535
 $V_c = 300 \text{ m/min}$, $a_p = 1.5 \text{ mm}$
 $f_z = 0.2 \text{ mm/t}$, SS400 Wet BT50

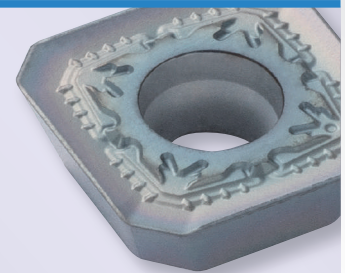

Reduces down-time and reduces burrs. Excellent chip control and extended automatic continuous operation time

*User evaluation

Strain

SUS 630 Equivalent Plate / Strain and Chatter Suppression



CG image

$\phi 63$
SEET13T3AGSN-SL PR1535
 $V_c = 120 \text{ m/min}$, $a_p = 0.3 \text{ mm}$
 $f_z = 0.08 \text{ mm/t}$, Equivalent to SUS 630 Wet BT40

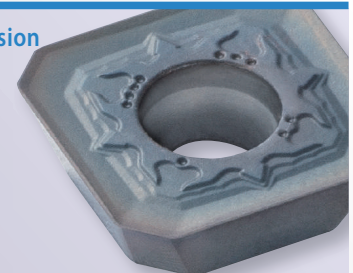

Reducing chatter by suppressing strain in stainless steel plate machining with a total length of 1m or more

MFSE45

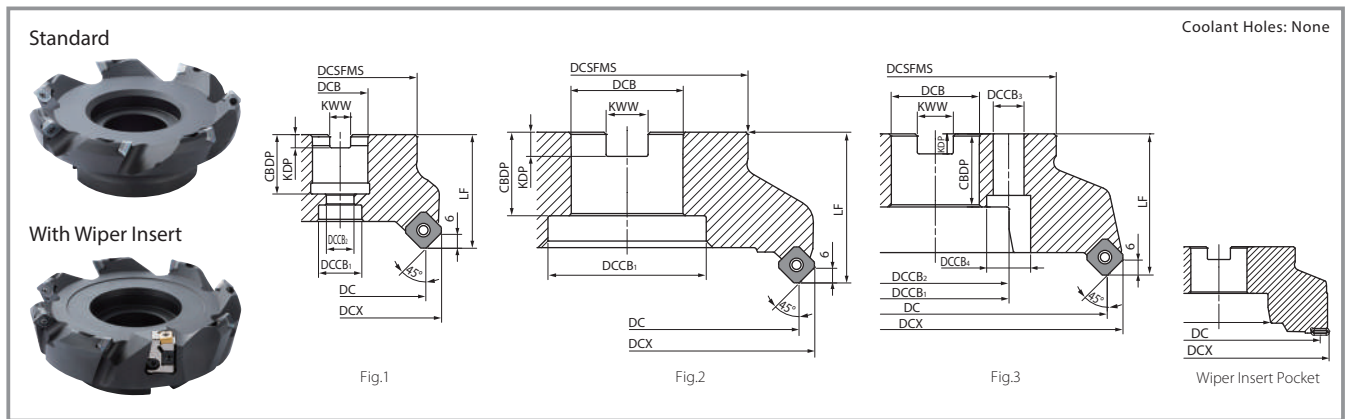

Toolholder Dimensions

Description	Stock	No. of Inserts	Dimensions (mm)											Cartridge	Shape	Weight (kg)	Max. Revolution (min ⁻¹)		
			DC	DCX	DCB	DCB ₁	DCB ₂	DCB ₃	DCB ₄	LF	CBDP	KDP	KWW						
Standard	Bore Dia. Inch spec	MFSE45080R-5T	MTO	5	80	88.7	25.4	20	13	-	-	50	27	6	9.5	No	Fig.1	1.4	12,800
		MFSE45100R-5T	MTO	5	100	108.7	31.75	48	-	-	-	50	32	8	12.7		1.9	11,500	
		MFSE45125R-6T	MTO	6	125	133.7	38.1	55	-	-	-	63	38	10	15.9		3.3	10,200	
		MFSE45160R/L-7T	MTO	7	160	168.7	50.8	72	-	-	-		38	11	19.1		5.3	9,000	
		MFSE45200R/L-8T	MTO	8	200	208.7	47.625	100	-	18	26		40	14	25.4		7.3	8,100	
		MFSE45250R/L-10T	MTO	10	250	258.7		110	-	18	26	40	14	25.4	15.8		7,200		
	Metric	MFSE45063R-5T-M	MTO	5	63	71.7	22	-	5	-	-	50	21	6.3	10.4	No	Fig.1	0.6	14,400
		MFSE45080R-5T-M	MTO	5	80	88.7	27	-	5	-	-		24	7	12.4			1.4	12,800
		MFSE45100R-5T-M	MTO	5	100	108.7	32	-	5	-	-		30	8	14.4		1.8	11,500	
		MFSE45125R-6T-M	MTO	6	125	133.7	40	-	6	-	-	63	33	9	16.4		3.2	10,200	
		MFSE45160R-7T-M	MTO	7	160	168.7	40	-	7	14	20		32	9	16.4		5.4	9,000	
		MFSE45200R-8T-M	MTO	8	200	208.7	60	-	8	18	26		40	14	25.7		7.0	8,100	
		MFSE45250R-10T-M	MTO	10	250	258.7		-	10	18	26		40	14	25.7		15.5	7,200	
		Wiper Insert	Bore Dia. Inch spec	MFSE45160R-8T-W	MTO	8	160	168.7	50.8	72	-		-	63	38		11	19.1	Yes (Wiper insert only)
MFSE45200R-9T-W	MTO			9	200	208.7	47.625	133	-	18	26	40	14		25.4	7.6	800		
MFSE45250R-11T-W	MTO			11	250	258.7		133	-	18	26	38	14		25.4	12.3	800		
Metric	MFSE45160R-8T-W-M		MTO	8	160	168.7	40	1	8	-	-	63	33	9	16.4	Yes (Wiper insert only)	Fig.3	5.5	1,000
	MFSE45200R-9T-W-M		MTO	9	200	212.8	60	1	9	18	26		40	14	25.7			7.3	800
	MFSE45250R-11T-W-M		MTO	11	250	262.7		1	11	18	26		38	14	25.7			12.0	800

Maximum number of revolutions

MTO: Made to order

Set the number of revolutions per minute within the recommended cutting speed specified by the workpiece on the back cover. Do not use the end mill or cutter at the maximum revolution or higher since the centrifugal force may cause chips and parts to scatter even under no load.

Parts

Common for Standard/Wiper Insert

Clamp Screw	Wrench	Shim	Shim Screw	Shim Wrench	Anti-seize Compound
SB-35120TRP	DTPM-15	MFSE-105	SPW-5035	LW-3.5	P-37
Fastening Torque for Insert Clamp 4 N·m		Fastening Torque for Shim Clamp 5 N·m			

For Wiper Insert

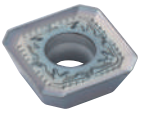
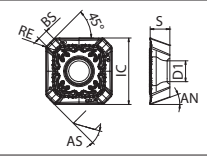
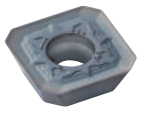
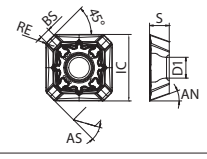
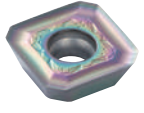
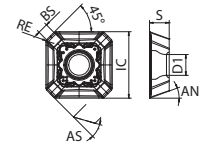

Clamp Screw	Wrench	Wedge	Cartridge	Cartridge Clamp Screw	Wrench	Adjustment Screw
SB-3592TR	DTM-10	AD-MFF	CR-MFF	HHSX15L	TTW-15	W6X18N
Fastening Torque for Wiper Insert Clamp 1.2 N·m						

Applicable Inserts

Usage Classification		P	Carbon Steel /Alloy Steel	★	☆	☆							
			Mold Steel	☆	★	☆							
★ : 1st Choice ☆ : 2nd Choice		M	Stainless Steel (SUS 304)	★	☆	☆							
			Stainless Steel (SUS 403: Martensitic)	★	☆	☆							
		K	Gray Cast Iron	☆	☆	☆							
			Nodular Cast Iron	☆	☆	★							
		N	Non-ferrous Metal				★						
Shape		S	Heat Resistant Alloy	☆									
			Titanium Alloy	☆									
Shape	Description	Dimensions (mm)					Angle		MEGACOAT NANO		CVD coating	DLC coating	
		IC	S	D1	RE	BS	AN	AS	PR1535	PR1525	CA6535	PDL025	
		SEET13T3AGSN-GL	13.4	3.97	4.2	1.5	2.1	20°	29°	●	●	●	
		SEET13T3AGSN-SL	13.4	3.97	4.2	1.5	2.1	20°	29°	●	●	●	
		SEET13T3AGFN-AL	13.4	3.97	4.2	1.5	2.1	20°	29°				●

● : Standard Stock

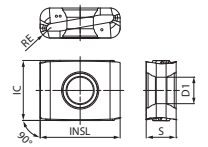
Wiper Insert

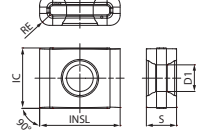
Shape	Description	Dimensions (mm)					MEGACOAT NANO Cermet	MEGACOAT NANO	
		IC	S	D1	INSL	RE	PV60M	PR1525	
 For steel and stainless steel (Low cutting force)		LNGX 120916R-TT	9.525	4.76	4.2	12.7	1.6	MTO	MTO
 For cast iron		LNGX 120916	9.525	4.76	4.2	12.7	1.6	MTO	MTO

MTO : Made to order

About Cutting Edge Adjustment

1. Use the supplied TTW-15 wrench to rotate the screw and easily adjust the cutting edge position.
2. Thread in one direction clockwise (Fig. 1) when adjusting.

If the adjustment is completed with the screw rotated counterclockwise, the screw will become loose and chatter due to backlash.

*Since the insert cutting edge of this product has an arc shape, it cannot be adjusted correctly if the measurement position is different.

3. To adjust, start with the screw turned counterclockwise about two rotations (lowering the cutting edge).

Tighten the screws clockwise (raising the cutting edge) until the insert with the highest edge (Fig. 2) catches 60 μm. (Fig. 3)

*Use a dial gauge to measure protrusion amount.

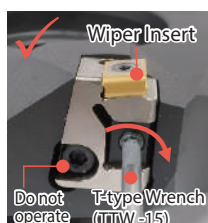

Fig. 1 Adjustment Direction



Rough edge Fig. 2



Wiper insert Fig. 3

Recommended Cutting Conditions Table ★ : 1st Recommendation ☆ : 2nd Recommendation

Chipbreaker	Workpiece	fz (mm/t)	Recommended Insert Grade (Cutting speed Vc: m/min)			
			PR1535	PR1525	CA6535	PDL025
GL	Carbon Steel (S ** C, etc.)	0.1 - 0.15 - 0.3	★ 150 - 200 - 300	☆ 150 - 200 - 300	☆ 150 - 200 - 300	—
	Alloy Steel (SCM, etc.)	0.1 - 0.15 - 0.3	★ 150 - 200 - 300	☆ 150 - 200 - 300	☆ 150 - 200 - 300	—
	Mold Steel (SKD, etc.)	0.1 - 0.15 - 0.25	☆ 100 - 150 - 250	★ 100 - 150 - 250	☆ 100 - 150 - 250	—
	Austenitic Stainless Steel * (SUS 304, etc.)	0.1 - 0.15 - 0.25	★ 100 - 200 - 250	☆ 100 - 200 - 250	☆ 100 - 200 - 250	—
	Martensitic Stainless Steel * (SUS 403, etc.)	0.1 - 0.15 - 0.25	★ 100 - 200 - 250	☆ 100 - 200 - 250	☆ 100 - 200 - 250	—
	Gray Cast Iron (FC)	0.1 - 0.15 - 0.25	☆ 100 - 200 - 250	☆ 100 - 200 - 250	☆ 100 - 200 - 250	—
	Nodular Cast Iron (FCD)	0.1 - 0.15 - 0.25	☆ 100 - 200 - 250	☆ 100 - 200 - 250	★ 100 - 200 - 250	—
SL	Carbon Steel (S ** C, etc.)	0.1 - 0.12 - 0.15	☆ 150 - 200 - 300	☆ 150 - 200 - 300	☆ 150 - 200 - 300	—
	Alloy Steel (SCM, etc.)	0.1 - 0.12 - 0.15	☆ 150 - 200 - 300	☆ 150 - 200 - 300	☆ 150 - 200 - 300	—
	Mold Steel (SKD, etc.)	—	—	—	—	—
	Austenitic Stainless Steel * (SUS 304, etc.)	0.1 - 0.15 - 0.2	★ 100 - 200 - 250	☆ 100 - 200 - 250	☆ 100 - 200 - 250	—
	Martensitic Stainless Steel * (SUS 403, etc.)	0.1 - 0.15 - 0.2	★ 100 - 200 - 250	☆ 100 - 200 - 250	☆ 100 - 200 - 250	—
AL	Aluminum Alloy (Si 13% or less)	0.1 - 0.15 - 0.3	—	—	—	★ 200 - 400 - 500

*Machining with coolant is recommended for stainless steel machining.

Bold text in the table indicates recommended values. Adjust the cutting speed and feed within the above conditions according to the actual machining situation.