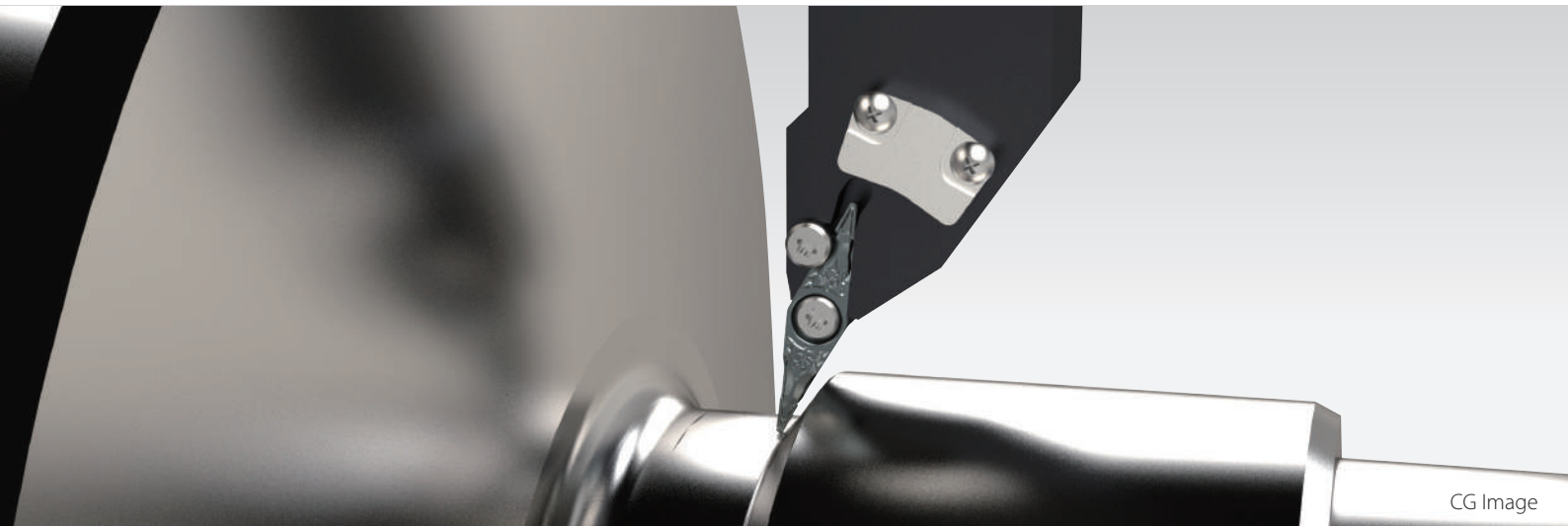

25° Insert Profiling Tools

ZBMT Series

**NEW**

CG Image

25° Insert Tip with Greater Maneuverability Shortens Machining Processes and Reduces Costs

Wide lineup of toolholders from external turning to boring bars. Supports a wide range of applications, including copying, undercutting, tapering, V slotting, etc.

Improved dimensional accuracy with unique clamp structure
Firm insert clamping results in high precision and stable machining

Newly developed GF chipbreaker for ZBMT inserts. Reduces chip control issues when machining at minute depths of cut

15° insert tip angle also available



25° Insert Profiling Tools

ZBMT Series

Unique clamping structure and a wide lineup of external toolholders and boring bars. High precision and stable machining in a wide range of applications including copying, undercutting, tapering, V-slotting, spherical machining, and more.

New 25° Inserts Achieve Excellent Results Using a Large Variety of Toolholders

Challenges

Workpiece geometries are becoming more complex and can be difficult to machine with typical 35° V-style inserts. Specialized tools focusing on shape often sacrifice rigidity, accuracy, or chip control.

Solution

The 25° ZBMT insert adopts a strong and unique clamp mechanism for added rigidity. This rigidity adds precision and stability in a variety of machining applications for shorter cycle times and lower machining costs.



Large 25° Tooling Lineup

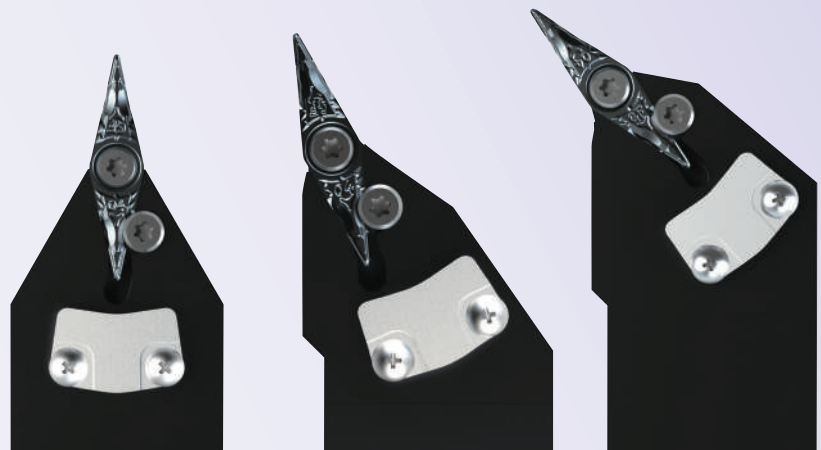

Custom holder cutting angles, polygon taper shanks, etc. are available by request.

Please contact your Kyocera sales representative for details.

1

Newly Developed Self-Clamping Mechanism Achieves a Higher Rigidity

Side Lock Mechanism

Unique design holds insert at 2 points

Safe even for insert with small tip angle that is difficult to mount



Indentations for screw clamp are designed into the insert's body

Uses a large screw size (M4)

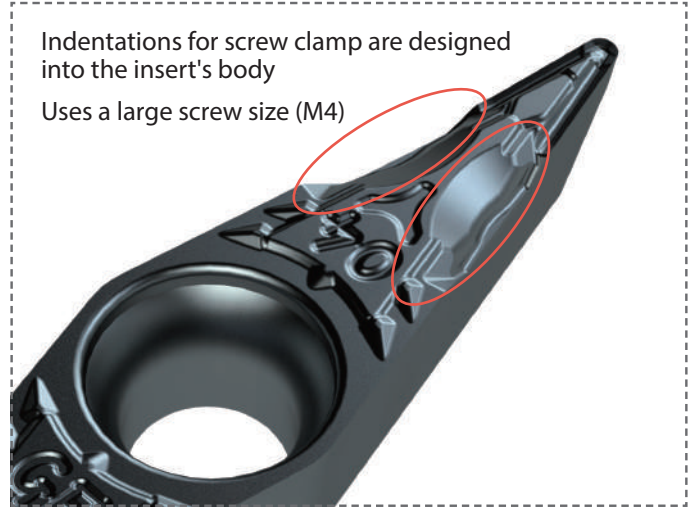

Insert Displacement During Facing Comparison (Internal evaluation)

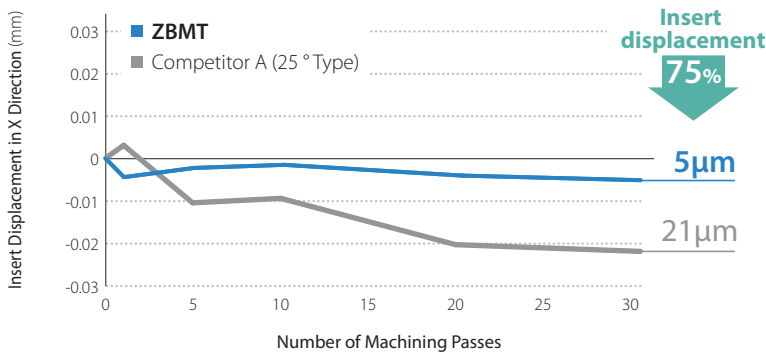

Cutting Conditions : Vc = 230 m/min, ap = 0.3 mm, f = 0.15 mm/rev, Wet Workpiece SCM435

*The above figures are not guaranteed. It depends on cutting conditions.

Check

By controlling insert displacement,

- Machining precision is stabilized and long tool life is enable
- Reduces defect rate due to sudden dimensional deviation

*Please check **P5** for how to attach and detach insert using the new insert clamp

Provides High Quality and Stable Machining in Various Machining Applications

Excellent Performance in Various Machining Applications including Copying, Undercutting, Tapering, V-Slotting, Spherical Machining, etc.



CG images

2

Unique Holder Design to Meet Customers' Needs

Both boring bars and external toolholders are compatible with internal coolant.

Unique Double Coolant Hole Design

Supplies coolant directly to the cutting edge and provides improved chip evacuation and long tool life (Coolant discharge direction: Fine adjustment possible)

*Though coolant stream hits side clamp screw, machining performance is not affected

*Pressure resistance: ~ 3 MPa

Uses a clamp with a small thickness that does not prevent chip flow

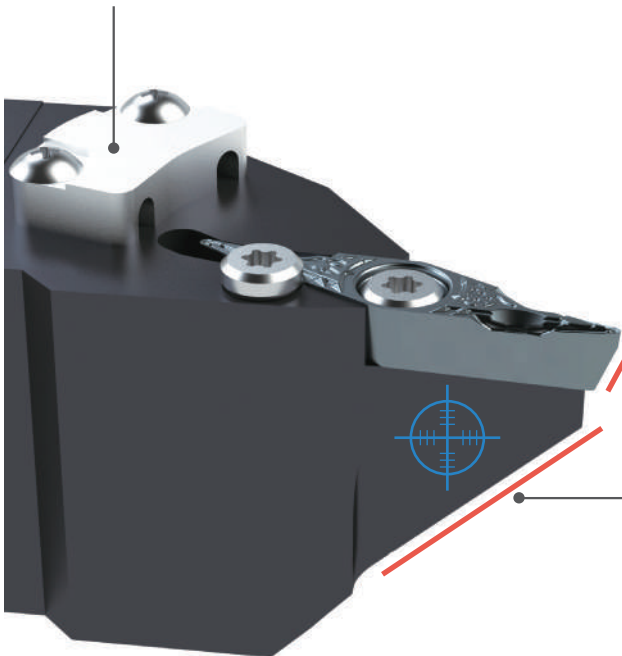

Fine Tuned and Adjustable

± 4 ° Adjustable Oscillation

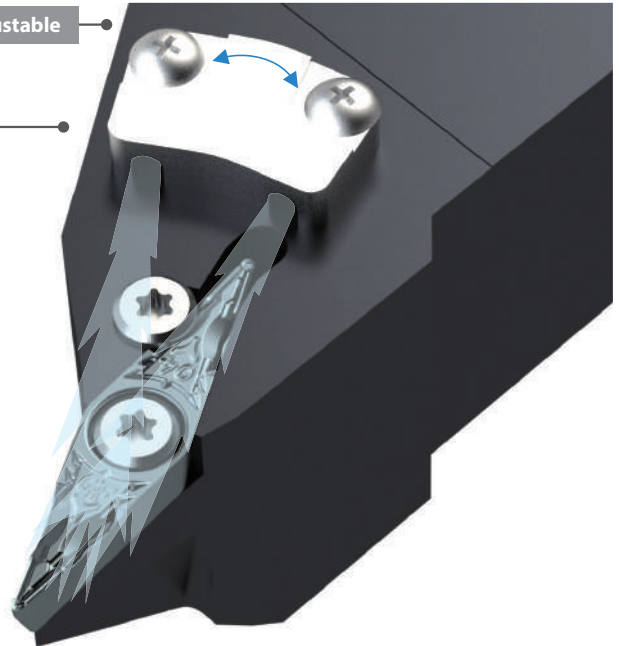

Easy to use for Facing

Insert corner : 2-Step Positive Type (20°)

Holder: Tapered shape

Inserts and toolholders have a unique end shape

No additional machining is required when trying to avoid interference with workpiece.

Effective for facing applications



Great Solution Significant reduction in quality defect costs

(User evaluation)

Suppresses dimensional fluctuations due to insert displacement.
Reduces defect rates.

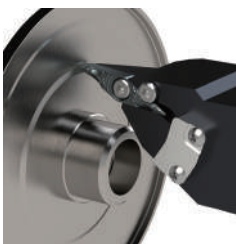

Dimensional defect rate

GF Chipbreaker

Competitor B

100 +/-month

Defect rate
Reduction



Cutting Conditions : Vc = 230 m/min, ap = 0.3 mm, f = 0.15 mm/rev, Wet
Workpiece SCM435

GF Chipbreaker chip condition



Customer Feedback

- Some parts require an insert with a tip angle of 25 ° to allow machining.
- The dimensional error of the GC chipbreaker was drastically improved in comparison with the competitors.
- Greatly reduced the cost of quality defects

GF Chipbreaker

Solving chip control issues leads to high-quality surface finishes

The thin molded chipbreaker extends near the corner and reliably controls chips even in narrow spaces

Two-step dot

Responds to chip fluctuation

Molded cutting edge

Improved chip control at small D.O.C.

Mortar-shaped chipbreaker

Low resistance and excellent chip control even in ductile workpieces

Chip control comparison
(Internal evaluation)



GF Chipbreaker



Competitor A (25° Type)

Cutting Conditions : Vc = 230 m/min, f = 0.15 mm/rev, ap = 0.2 - 0.5 mm, Wet Workpiece SCM435 Facing

15° Inserts are also available upon customer requests

To avoid holder interference, additional modifications is required as shown in the figure on the right (Details: P8). Also, as shown in the figure below, special order for holders may be required depending on machining application.

Examples

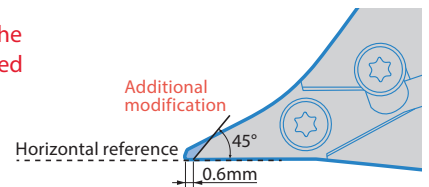
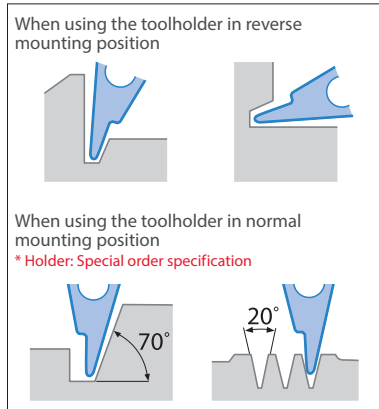

15° inserts are developed relative to 25° inserts
Helps avoid interference and supports a wider range of machining application

Corner-R0.4
Double-blade design for turning and back turning

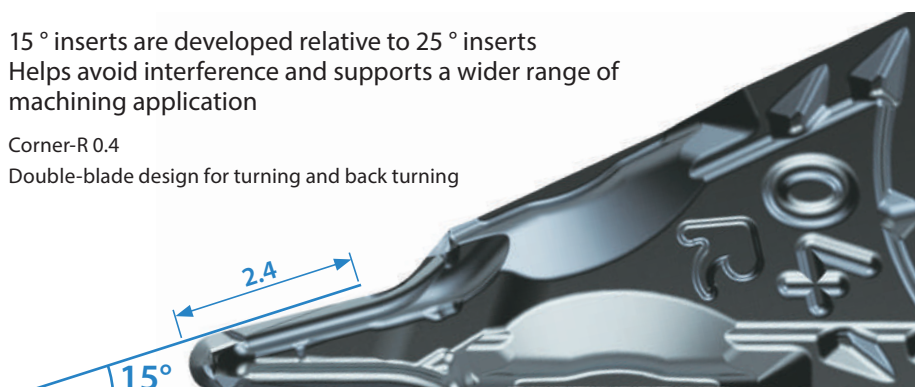

Kyocera's high-performance insert grade

PR1725 First recommendation for steel machining. Excellent surface finish and long tool life

MEGACOAT NANO PLUS

AlTiN/AlCrN Nano laminated film with superior wear resistance and adhesion resistance

<Reduces cracking>
Reduces abnormal damages such as chipping because of increased lamination layer with a thinner gap than conventional coatings.

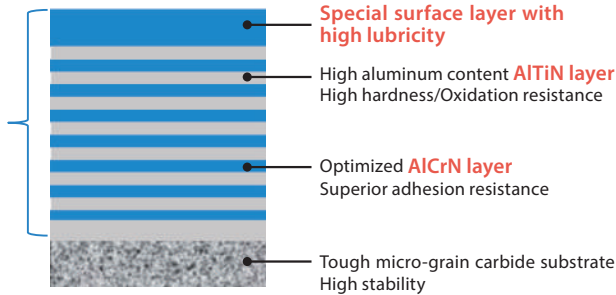

Wear Coefficient Comparison (Internal evaluation)

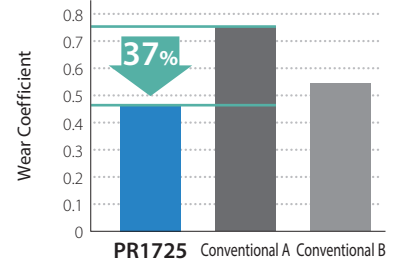

PR1535 The combination of a tough substrate and a special nano coating layer creates long tool life and stable machining in stainless steel machining

MEGACOAT NANO

- Point 1** An increase in cobalt content yields a substrate with greater toughness *In comparison to our conventional material grade
- Point 2** Improved stability by optimization and homogenization of grains in the base material
- Point 3** MEGACOAT NANO coating technology for long tool life and stable machining

↑ 23%
Fracture toughness *

Cracking Comparison by Diamond Indenter (Internal evaluation)



MEGACOAT Base Layer Structure

Point
PR1535 also shows superior performance in steel machining under unstable conditions

Instructions

When mounting the insert (Tightening torque: 1.2 N · m)



1. Tighten the main screw with the insert pressed against the contact surface with fingertips.

2. Tighten the side screw to complete the installation.

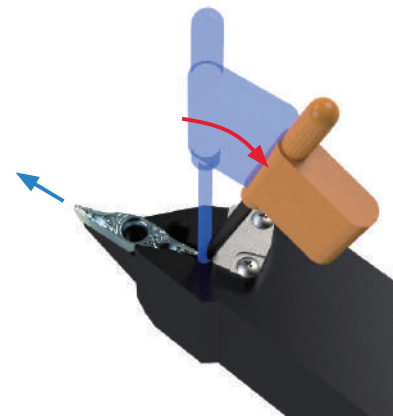

When removing the insert



Remove the two screws and put the wrench into the gap at the back end of the insert. It can be easily removed by pushing out the insert as shown above.

Insert Description

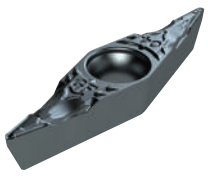
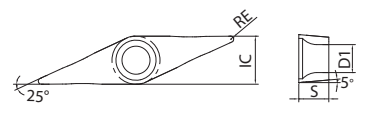
Carbide coating

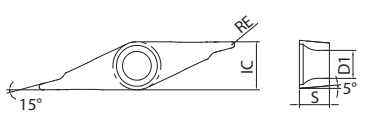
Shape	Description	Dimensions (mm)				MEGACOAT NANO PLUS	MEGACOAT NANO	
		IC	S	D1	RE	PR1725	PR1535	
 Tip Angle 25°		ZBMT 13T302GF	6.35	3.97	5.3	0.2	●	●
		13T304GF				0.4	●	●
		13T308GF				0.8	●	●
 Tip Angle 15° (Right Hand R)		ZBMT 13T304R-GF-15D	6.35	3.97	5.3	0.4	●	●

Because insert has a molded shape, the tip angle may be 24° depending on the measurement location.

● : Standard Stock

Recommended Cutting Conditions Tables

Workpiece	Insert tip angle	Corner-R (RE)	Insert Grade	Vc (m/min)	ap (mm)	f (mm/rev)
Carbon Steel / Alloy Steel	25°	0.2	PR1725	60 - 150 - 200	0.2 - 0.3 - 1.5	0.05 - 0.10 - 0.15
			PR1535	60 - 120 - 180	0.2 - 0.3 - 1.5	0.05 - 0.10 - 0.15
		0.4 / 0.8	PR1725	60 - 150 - 200	0.2 - 0.3 - 2.0	0.05 - 0.15 - 0.25
			PR1535	60 - 120 - 180	0.2 - 0.3 - 2.0	0.05 - 0.15 - 0.25
	15°	0.4	PR1725	60 - 150 - 200	0.2 - 0.3 - 1.0	0.05 - 0.10 - 0.15
			PR1535	60 - 120 - 180	0.2 - 0.3 - 1.0	0.05 - 0.10 - 0.15
Stainless Steel	25°	0.2	PR1725	60 - 150 - 180	0.2 - 0.3 - 1.0	0.05 - 0.10 - 0.15
			PR1535	60 - 120 - 150	0.2 - 0.3 - 1.0	0.05 - 0.10 - 0.15
		0.4 / 0.8	PR1725	60 - 150 - 180	0.2 - 0.3 - 1.0	0.05 - 0.15 - 0.25
			PR1535	60 - 120 - 150	0.2 - 0.3 - 1.0	0.05 - 0.15 - 0.25
	15°	0.4	PR1725	60 - 150 - 180	0.2 - 0.3 - 1.0	0.05 - 0.10 - 0.15
			PR1535	60 - 120 - 150	0.2 - 0.3 - 1.0	0.05 - 0.10 - 0.15
Cast Iron	25°	0.2	PR1725	60 - 150 - 180	0.2 - 0.3 - 1.5	0.05 - 0.10 - 0.15
		0.4 / 0.8	PR1725	60 - 150 - 180	0.2 - 0.3 - 2.0	0.05 - 0.15 - 0.25
	15°	0.4	PR1725	60 - 150 - 180	0.2 - 0.3 - 1.0	0.05 - 0.10 - 0.15

When using machining at ap 1.5 mm or more, reduce the feed by about 50%.

External

SZLB (External/Copying)

Pressure resistance : ~ 3 MPa

Side Rake Angle : 0°
Angle of Inclination : 0°

Right-hand Shown

For ZBMT13T304R-GF-15D, the right-hand holder (R) is applicable.

SZPB (External/Facing/Copying/Undercutting)

Pressure resistance : ~ 3 MPa

Side Rake Angle : 0°
Angle of Inclination : 0°

Right-hand Shown

SZVBN (External/Copying)

Pressure resistance : ~ 3 MPa

Side Rake Angle : 0°
Angle of Inclination : 0°

Toolholder Dimensions

Description	Stock			Dimensions (mm)							Standard Corner-R (RE)	Coolant hole	Parts											
	R	N	L	H	HF	B	LF	LH	WF	MHD			Clamper	Clamp Screw (For Clamper)	Clamp Screw	Wrench								
SZLB ^{R/L}	2020K-13C	●	●	20	20	20	125	40	23	92.6	0.4	Yes	ZCP-13	BH2X6	SB-3079TR	FT-8								
	2525M-13C	●	●	25	25	25	150	40	28.2	118														
SZPB ^{R/L}	2020K-13C	●	●	20	20	20	125	37	27.2	95	0.4	Yes					ZCP-13	BH2X6	SB-3079TR	FT-8				
	2525M-13C	●	●	25	25	25	150	36	33.9	124.2														
SZVBN	2020K-13C		●	20	20	20	125	40	10	89.6	0.4	Yes									ZCP-13	BH2X6	SB-3079TR	FT-8
	2525M-13C		●	25	25	25	150	40	12.5	114.6														

Recommended tightening torque
1.2 N·m

● : Standard Stock

Piping Parts for External Toolholders

JCT series piping parts can be used for machining with internal coolant (Sold separately).

For details, please refer to **the 2020 to 2021 Kyocera general catalog**.

Joint/Banjo Bolt

Pressure resistance : ~ 30 MPa

Shape	Description	Stock	Thread Standard	
			Toolholder machine connection side	
	J-G1/8-UNF3/8	●	G1/8	
	J-M10X1.5-UNF3/8	●	M10X1.5	
Banjo Bolt (For Angle Hose)	BB-G1/8	●	G1/8	
	BB-M10X1.5	●	M10X1.5	

● : Standard Stock

Washer

Pressure resistance : ~ 30 MPa

Shape	Description	Stock
	WS-10	●

*When using banjo bolts, two washers are required.

● : Standard Stock

Hose

Pressure resistance : ~ 30 MPa

Shape	Description	Stock	Thread Standard		Dimensions (mm)
					L
Straight/Straight	HS-ST-ST-200	●	UNF3/8	UNF3/8	200
	HS-ST-ST-250	●			250
Straight/Angle	HS-ST-AN-200	●	UNF3/8	-	200
	HS-ST-AN-250	●			250
Angle/Angle	HS-AN-AN-200	●	-	-	200
	HS-AN-AN-250	●			250

● : Standard Stock

Boring/Facing Available Cutting Diameter and Maximum D.O.C.

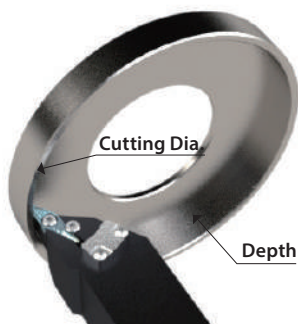

Standard Corner-R 0.4 (RE)

Cutting Dia.	Depth (mm)
ø30	0.5
ø50	1.5
ø65	3.0
ø80	6.0
ø100	10.0
ø150	14.0

SZPB Type Cutting Diameter for Undercutting

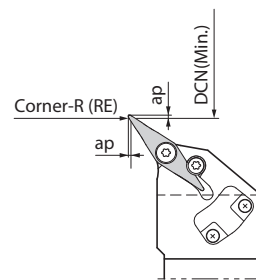

Corner-R (RE)	ap (mm)	DCN (Min.)
0.2	0.5	ø30
	1	ø35
0.4	0.5	ø30
	1	ø35
0.8	0.5	ø110
	1	ø150

How to Modify Toolholder when Using 15° Insert

When using 15° insert, additional modification is required for the holder to avoid interference.

Recommended Additional Modification

- Set the edge of insert bearing surface at the end of the holder at horizontal reference shown below.
- Modify the holder to 0.6 mm from the tip at an angle of not less than 45 degrees from the horizontal.

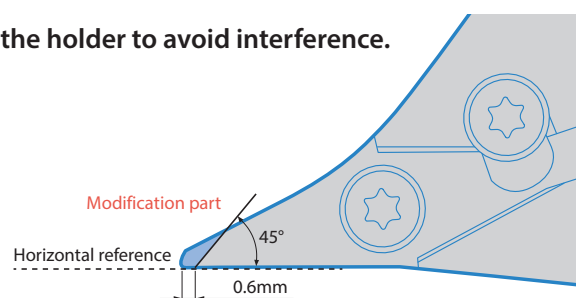

Boring Bar

Maximum overhang length L/D = ~ 5.5

A-SZJB-AE Excellent Bar (Internal Spherical Machining/Internal Facing/Copying)

Right-hand Shown

Left-hand (L) is the above shape

Shank Diameter	Straight Hole Diameter
ø20	ø5
ø25	
ø32	

For ZBMT13T304R-GF -15D, the right-hand holder (R) is applicable.

A-SZXB-AE Excellent Bar (Internal Facing/Copying/Undercutting)

Right-hand Shown

Left-hand (L) is the above shape

Shank Diameter	Straight Hole Diameter
ø20	ø5
ø25	
ø32	

A-SZQB-AE Excellent Bar (Copying/Undercutting)

Right-hand Shown

Left-hand (L) is the above shape

Shank Diameter	Straight Hole Diameter
ø20	ø5
ø25	
ø32	

A-SZLB-AE Excellent Bar (Copying)

Right-hand Shown

Left-hand (L) is the above shape

Shank Diameter	Straight Hole Diameter
ø20	ø5
ø25	
ø32	

For ZBMT13T304R-GF -15D, the left hand holder (L) is applicable

A-SZB-AE Excellent Bar (Back Boring)

Right-hand Shown

Left-hand (L) is the above shape

Shank Diameter	Straight Hole Diameter
ø20	ø5
ø25	
ø32	

For ZBMT13T304R-GF -15D, the right hand holder (R) is applicable.

Toolholder Dimensions

Toolholder Dimensions

Description	Stock		Minimum Cutting Dia.	Dimensions (mm)								GAMCO	Standard Corner-R (RE)	Coolant hole	Parts			
	R	L		DMIN	DCON	H	LPR	LF	LU	LH	WF				WF2	Clamp Screw	Wrench	Plug
	Excellent Bar																	
A20R-SZJB R/L13-28AE	●	●	28	20	19		200	37.5	48	3.0	-	5°	0.4	Yes	SB-3079TR	FT-8	HS3X3	
A25S-SZJB R/L13-30AE	●	●	30	25	24	-	250	47	58	3.5	-	5°	0.4	Yes	Recommended tightening torque 1.2 N · m		HS4X4	
A32S-SZJB R/L13-40AE	●	●	40	32	31		250	61.5	72	3.5	-	5°	0.4	Yes	SB-3079TR	FT-8	HS3X3	
A20R-SZXB R/L13-25AE	●	●	25	20	19		200	37.5	48	7.5	-	5°	0.4	Yes	Recommended tightening torque 1.2 N · m		HS4X4	
A25S-SZXB R/L13-30AE	●	●	30	25	24	-	250	45.2	58	7	-	5°	0.4	Yes	SB-3079TR	FT-8	HS3X3	
A32S-SZXB R/L13-40AE	●	●	40	32	31		250	60.2	74	7	-	5°	0.4	Yes	Recommended tightening torque 1.2 N · m		HS4X4	
A20R-SZQB R/L13-27AE	●	●	27	20	19		200	-	41	15.5	5.5	5°	0.4	Yes	SB-3079TR	FT-8	HS3X3	
A25S-SZQB R/L13-32AE	●	●	32	25	24	-	250	-	51	18	5.5	5°	0.4	Yes	Recommended tightening torque 1.2 N · m		HS4X4	
A32S-SZQB R/L13-40AE	●	●	40	32	31		250	-	54	22.5	6.5	5°	0.4	Yes	SB-3079TR	FT-8	HS3X3	
A20R-SZLB R/L13-30AE	●	●	30	20	19		200	-	42	23	13	7°	0.4	Yes	Recommended tightening torque 1.2 N · m		HS4X4	
A25S-SZLB R/L13-34AE	●	●	34	25	24	-	250	-	64	25.5	13	7°	0.4	Yes	SB-3079TR	FT-8	HS3X3	
A32S-SZLB R/L13-40AE	●	●	40	32	31		250	-	86	29	13	7°	0.4	Yes	Recommended tightening torque 1.2 N · m		HS4X4	
A20R-SZZB R/L13-30AE	●	●	30	20	19	200	187	-	42	23	13	7°	0.4	Yes	SB-3079TR	FT-8	HS3X3	
A25S-SZZB R/L13-34AE	●	●	34	25	24	250	237	-	58	25.5	13	7°	0.4	Yes	Recommended tightening torque 1.2 N · m		HS4X4	
A32S-SZZB R/L13-40AE	●	●	40	32	31	250	237	-	74	29	13	7°	0.4	Yes	SB-3079TR	FT-8	HS3X3	

Minimum cutting dia. when installing with standard corner-R (RE) insert
 When machining with an insert other than the standard corner-R (RE), there may be interference.

● : Standard Stock

Identification System

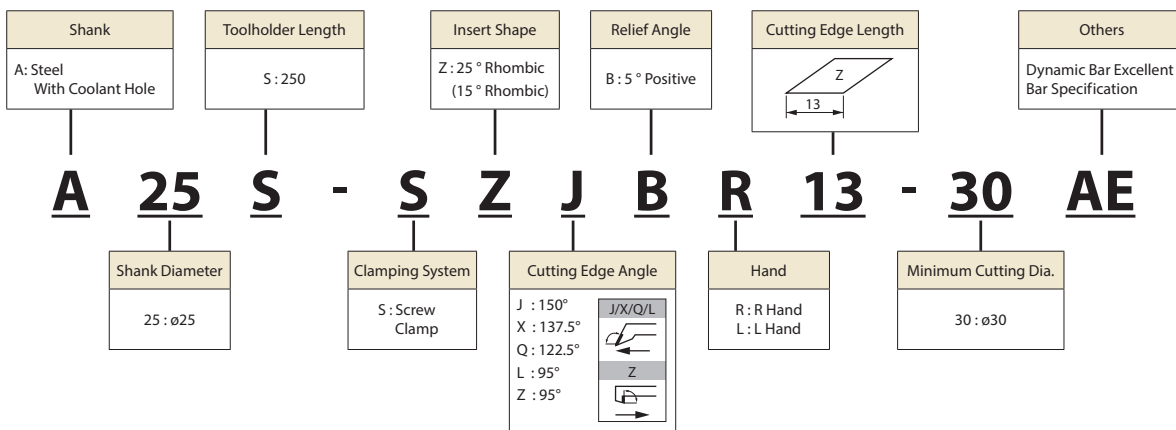

Unique Cutting Angle A-SZXB-AE (Internal Facing/Copying/Undercutting)

Features

- **Chatter-resistant shape**
The insert is placed near the center of the shank to ensure the thickness of the lower jaw of the insert.
- **User-friendly design**
The holder width (WF + Neck radius) is small, and it is easy to apply to the narrow gap of the workpiece (Minimum cutting dia. DMIN: Determined by R near the holder edge).



Inner Spherical Machining/Internal Facing/Copying (A-SZJB-AE)

Application Range

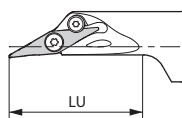
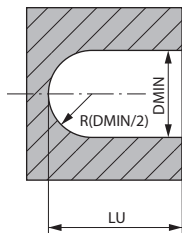

DMIN : $\phi 28 - \phi 40$

Applications

Without pre-drilled hole

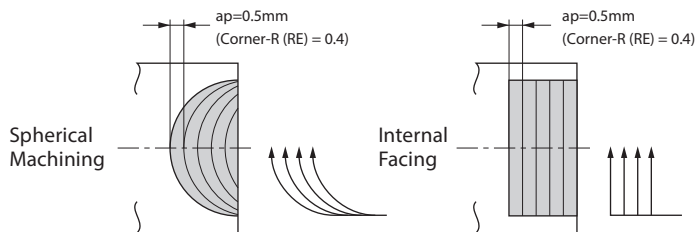

* f should be 0.05 mm/rev or less at internal facing.

Machining from drilled hole

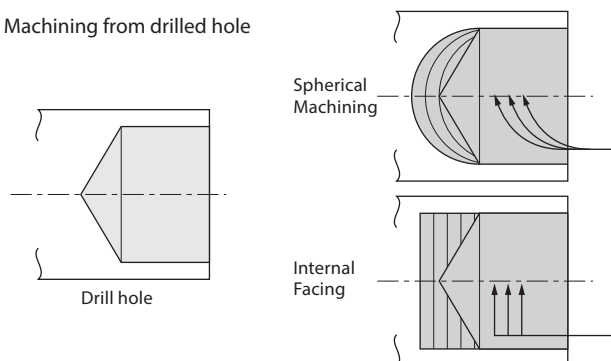

* f should be 0.05 mm/rev or less at internal facing.

Finishing

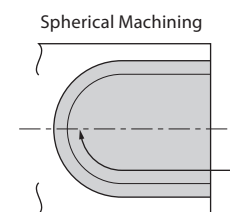

Internal Facing

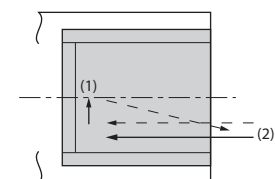

Machining Process

1. Finish the internal face first.
2. Next, finish the internal surface.

Caution

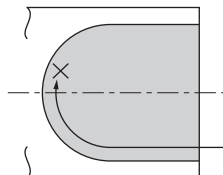

Internal spherical machining and internal facing (Especially internal spherical machining) When machining past the center of the workpiece, insert may break.

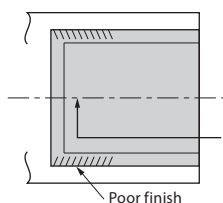
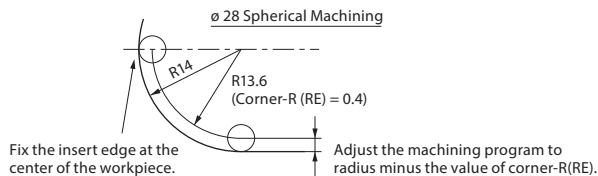

This type of machining is possible, but the chips might scratch the surface.

When internal copying as shown in the right figure, keep ap less than or equal to the corner-R(RE).

